

## Design Example Report

<b>Title</b>	<b><i>42 W 2-Stage Boost and Isolated Flyback PWM Dimmable LED Ballast Using HiperPFS™-4 PFS7623C and LYTSwitch™-6 LYT6067C</i></b>
<b>Specification</b>	198 VAC – 265 VAC Input; 30 V – 42 V, 1 A Output
<b>Application</b>	PWM Dimmable LED Ballast: 1% to 100%
<b>Author</b>	Applications Engineering Department
<b>Document Number</b>	DER-843
<b>Date</b>	January 20, 2020
<b>Revision</b>	1.0

### **Summary and Features**

- With integrated PFC function, PF >0.95
- Very Low THD <10%
- Accurate output voltage and current regulation, ±5%
- Very low ripple current, <10% of I<sub>OUT</sub>
- Highly energy efficient, >88%
- Low cost and low component count for compact PCB solution
- Non-dimmable and dimmable LED application
- Compatible with isolated PWM dimming module with functions:
  - 5 V PWM signal (Frequency range: 300 Hz to 1 kHz)
  - 1% to 100% Variable Duty Cycle
- Integrated protection and reliability features
  - Output short-circuit
  - Line and output OVP
  - Line surge or line overvoltage
  - Thermal foldback and over temperature shutdown with hysteretic automatic power recovery
- No damage during line brown-out or brown-in conditions
- Meets IEC 2.5 kV ring wave, 1 kV differential surge
- Meets EN55015 conducted EMI

### **Power Integrations**

5245 Hellyer Avenue, San Jose, CA 95138 USA.  
Tel: +1 408 414 9200 Fax: +1 408 414 9201  
www.power.com

**PATENT INFORMATION**

The products and applications illustrated herein (including transformer construction and circuits external to the products) may be covered by one or more U.S. and foreign patents, or potentially by pending U.S. and foreign patent applications assigned to Power Integrations. A complete list of Power Integrations' patents may be found at [www.power.com](http://www.power.com). Power Integrations grants its customers a license under certain patent rights as set forth at <https://www.power.com/company/intellectual-property-licensing/>.



## Table of Contents

1	Introduction .....	5
2	Power Supply Specification .....	8
3	Schematic .....	9
4	Circuit Description .....	10
4.1	Input EMI Filter and Rectifier .....	10
4.2	First Stage: Boost PFC Using HiperPFS-4 .....	11
4.3	Second Stage: Isolated Flyback DC-DC Using LYTSwitch-6 .....	13
4.4	PWM Dimming Circuit: 1% to 100% .....	15
4.4.1	PWM Dimming Control Circuit Function .....	15
4.4.2	How the Dimming Control Circuit Works .....	16
5	PCB Layout .....	20
5.1	Main Board Layout .....	20
5.2	Dimming Circuit Board Layout .....	21
6	Bill of Materials .....	22
6.1	Main BOM .....	22
6.2	Dimming Board BOM .....	24
6.3	Miscellaneous Parts .....	24
7	PFC Inductor (T2) Specifications .....	25
7.1	Electrical Diagram .....	25
7.2	Electrical Specifications .....	25
7.3	Material List .....	25
7.4	Inductor Build Diagram .....	26
7.5	Inductor Construction .....	26
7.6	Winding Illustrations .....	27
8	Flyback Transformer (T4) Specifications .....	29
8.1	Electrical Diagram .....	29
8.2	Electrical Specifications .....	29
8.3	Material List .....	29
8.4	Transformer Build Diagram .....	30
8.5	Transformer Construction .....	30
8.6	Winding Illustrations .....	31
9	PFC Boost Transformer Spreadsheet .....	35
10	Flyback DC-DC Transformer Spreadsheet .....	40
11	Performance Data .....	43
11.1	CV/CC Output Characteristic Curve .....	43
11.2	System Efficiency .....	44
11.3	Output Current Regulation .....	45
11.4	Power Factor .....	46
11.5	%ATHD .....	47
11.6	Individual Harmonic Content at 42 V LED Load .....	48
11.7	Individual Harmonic Content at 30 V LED Load .....	49
11.8	No-Load Input Power of Power Board .....	50
12	Test Data .....	51

12.1	42 V LED Load.....	51
12.2	39 V LED Load.....	51
12.3	36 V LED Load.....	51
12.4	33 V LED Load.....	51
12.5	30 V LED Load.....	52
12.6	No-Load.....	52
12.7	Individual Harmonic Content at 42 V LED Load.....	53
12.8	Individual Harmonic Content at 30 V LED Load.....	54
13	Dimming Performance.....	55
13.1	Dimming Curve.....	55
13.1.1	1% to 10% Duty Cycle.....	55
13.1.2	10% to 100% Duty Cycle.....	56
14	Thermal Performance.....	57
14.1	Thermal Scan at 25 °C Ambient.....	57
14.1.1	Thermal Scan at 265 VAC Full Load.....	58
14.2	Thermal Performance at 60 °C Ambient.....	60
15	Waveforms.....	61
15.1	Input Voltage and Input Current at 42 V LED Load.....	61
15.2	Start-up Profile at 42 V LED Load.....	62
15.3	Output Current Fall at 42 V LED Load.....	63
15.4	AC Cycling Test at 42 V.....	64
15.4.1	500 ms, OFF 500 ms ON.....	64
15.4.2	2 s OFF, 2 s ON.....	65
15.5	PFS7623C (U2) Drain Voltage and Current at Normal Operation.....	66
15.6	PFS7623C (U2) Drain Voltage and Current at Start-up.....	67
15.7	LYTSwitch-6 (U4) Drain Voltage and Current at Normal Operation.....	68
15.8	LYTSwitch-6 (U4) Drain Voltage and Current at Start-up.....	69
15.9	LYTSwitch-6 (U4) Drain Voltage and Current during Output Short-Circuit.....	71
15.10	Input Power during Output Short-Circuit.....	71
15.11	Output Ripple Current at 42 V LED Load.....	72
16	Conducted EMI.....	73
16.1	Test Set-up.....	73
16.2	Equipment and Load Used.....	73
16.2.1	EMI Test Results.....	74
17	Line Surge.....	75
17.1	Differential Surge Test Results.....	75
17.2	Ring Wave Surge Test Results.....	75
18	Brown-in/Brown-out Test.....	76
19	Revision History.....	77

**Important Note:** Although this board is designed to satisfy safety isolation requirements, the engineering prototype has not been agency approved. Therefore, all testing should be performed using an isolation transformer to provide the AC input to the prototype board.



## 1 Introduction

This engineering report describes a constant voltage (CV) and constant current (CC) output 42 W LED ballast with 1% to 100% PWM dimming function. At constant voltage application, the LED ballast is designed to provide a 42 V output voltage across 0 mA to 1000 mA output current load while at constant current mode operation, it can provide 1000 mA (PWM dimmable) constant current at 42 V – 33 V LED voltage string. The design is optimized to operate from an input voltage range of 198 VAC to 265 VAC.

The LED ballast employs a two-stage design with a boost PFC at first stage and an isolated flyback DC-DC for the secondary stage. The boost PFC utilizes HiperPFS-4 device while the second stage flyback uses LYTSwitch-6 controller.

The HiperPFS-4 devices incorporate a continuous conduction mode (CCM) boost PFC controller, gate driver and 600 V power MOSFET in a single power package. This device eliminates the need for external current sense resistors and their associated power loss, and use an innovative control technique that adjusts the switching frequency over output load, input line voltage, and input line cycle.

LYTSwitch-6 ICs simplifies the flyback stage by combining primary, secondary and feedback circuits in a single surface IC. This IC includes an innovative new technology, FluxLink™, which safely bridges the isolation barrier and eliminates the need for an optocoupler. The single architecture of LYTSwitch-6 allows the IC to have primary and secondary controllers, with sense elements and a safety-rated mechanism into a single IC.

DER-843 key design goals offer high power factor (>0.90), very low THD (<10%), low ratio dimming curve of 42 W LED ballast up to 1% of output current, high efficiency, and low component count at high-line input voltages.

The document contains the power supply specification, schematic, bill of materials, transformer documentation, printed circuit layout, and performance data.



Figure 1 – Populated Circuit Board.

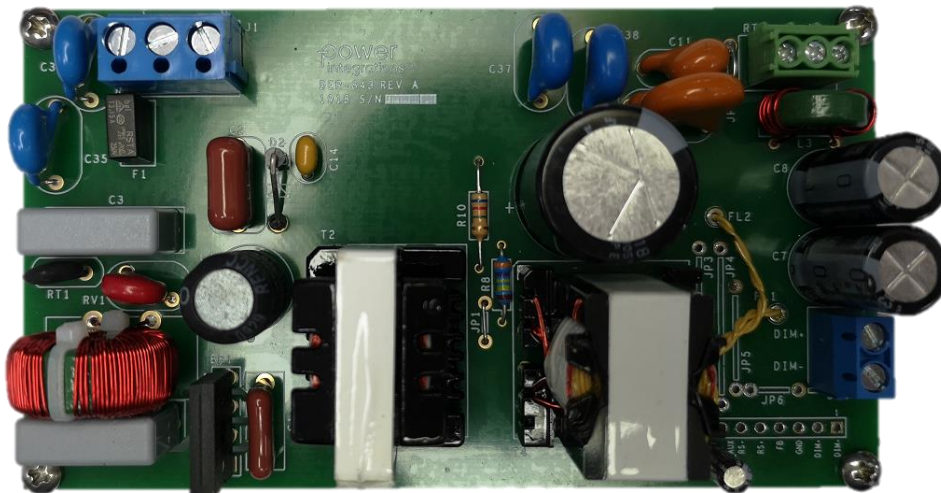
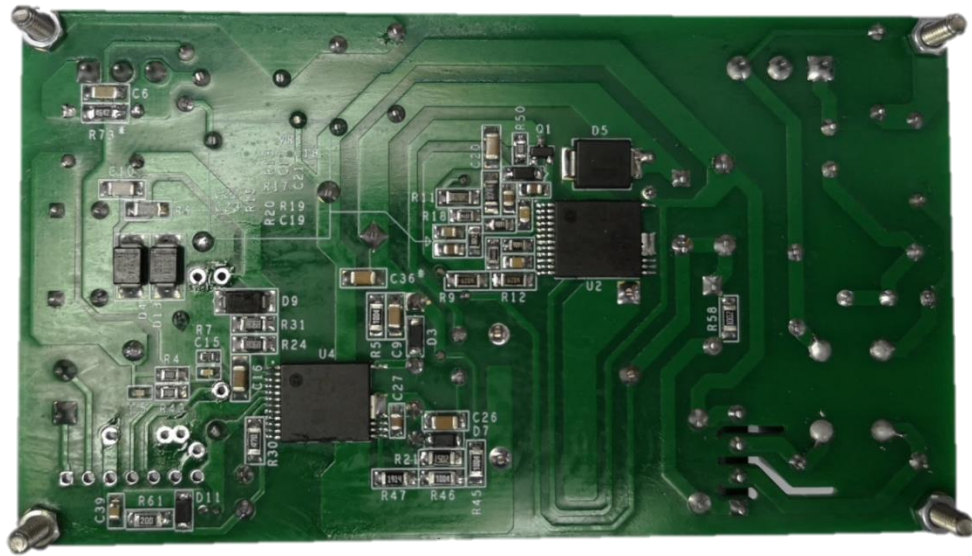


Figure 2 – Populated Circuit Board, Top View.



**Figure 3** – Populated Circuit Board, Bottom View.

## 2 Power Supply Specification

The table below represents the minimum acceptable performance of the design. Actual performance is listed in the results section.

Description	Symbol	Min	Typ	Max	Units	Comment
<b>Input</b>						
Voltage	$V_{IN}$	198	230 / 50	277	VAC / Hz	2-Wire Floating Output or 3-Wire with P.E.
Frequency	$f_{LINE}$					
<b>Output</b>						
Output Voltage	$V_{OUT}$		42		V	±5%
Output Current	$I_{OUT}$	950	1000	1050	mA	
<b>Total Output Power</b>						
Continuous Output Power	$P_{OUT}$		42		W	
<b>Efficiency</b>						
Full Load	$\eta$		88	89	%	230 V / 50 Hz at 25 °C.
<b>Environmental</b>						
Conducted EMI			CISPR 15B / EN55015B			
Safety			Isolated			
Ring Wave (100 kHz)			2.5		kV	
Differential Mode (L1-L2)			1.0		kV	
Power Factor			0.9			Measured at 230 VAC / 50 Hz.
Ambient Temperature	$T_{AMB}$			60	°C	Free Air Convection, Sea Level.



### 3 Schematic

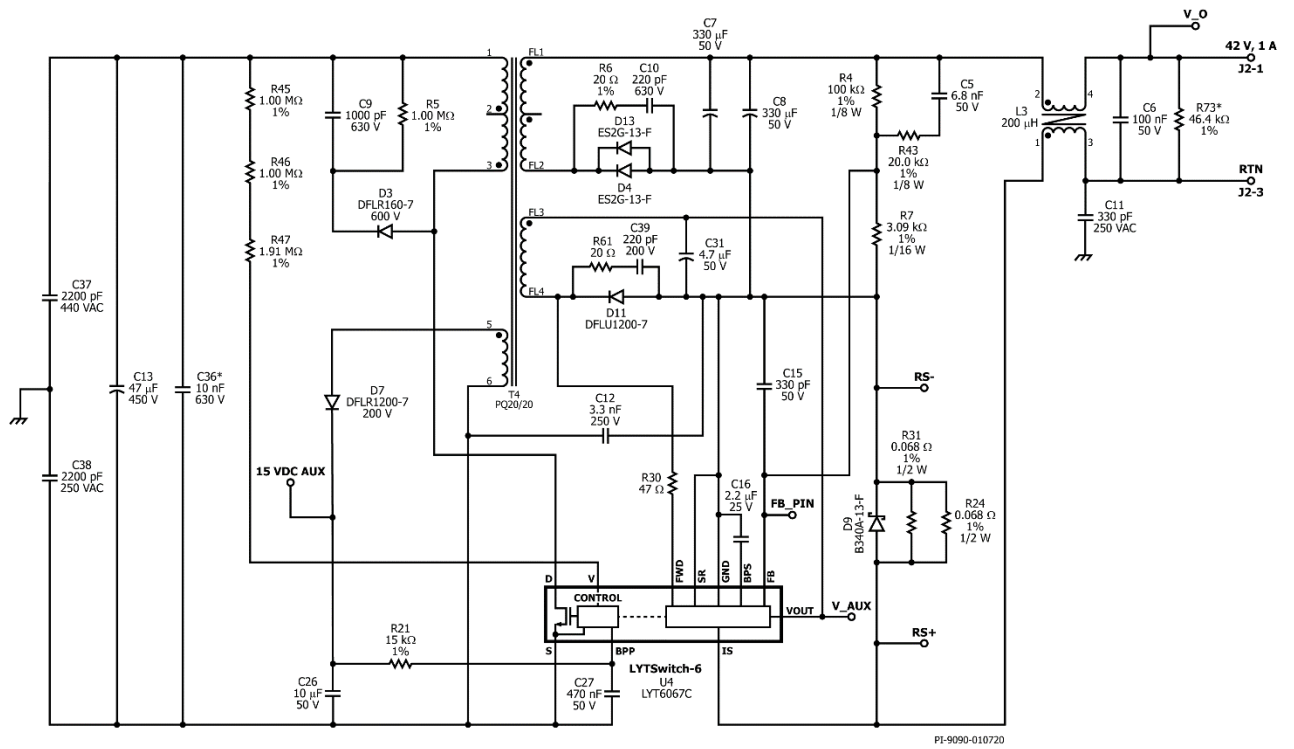


Figure 4 – Power Section Schematic.



## 4 Circuit Description

The LED ballast circuit employs two-stage PFC and DC-DC power supply with PWM dimming up to 1% of the output load. The first stage is a boost PFC using PFS7623C from the HiperPFS-4 family of devices. The second stage is an isolated flyback DC-DC power supply using a LYTSwitch-6 IC.

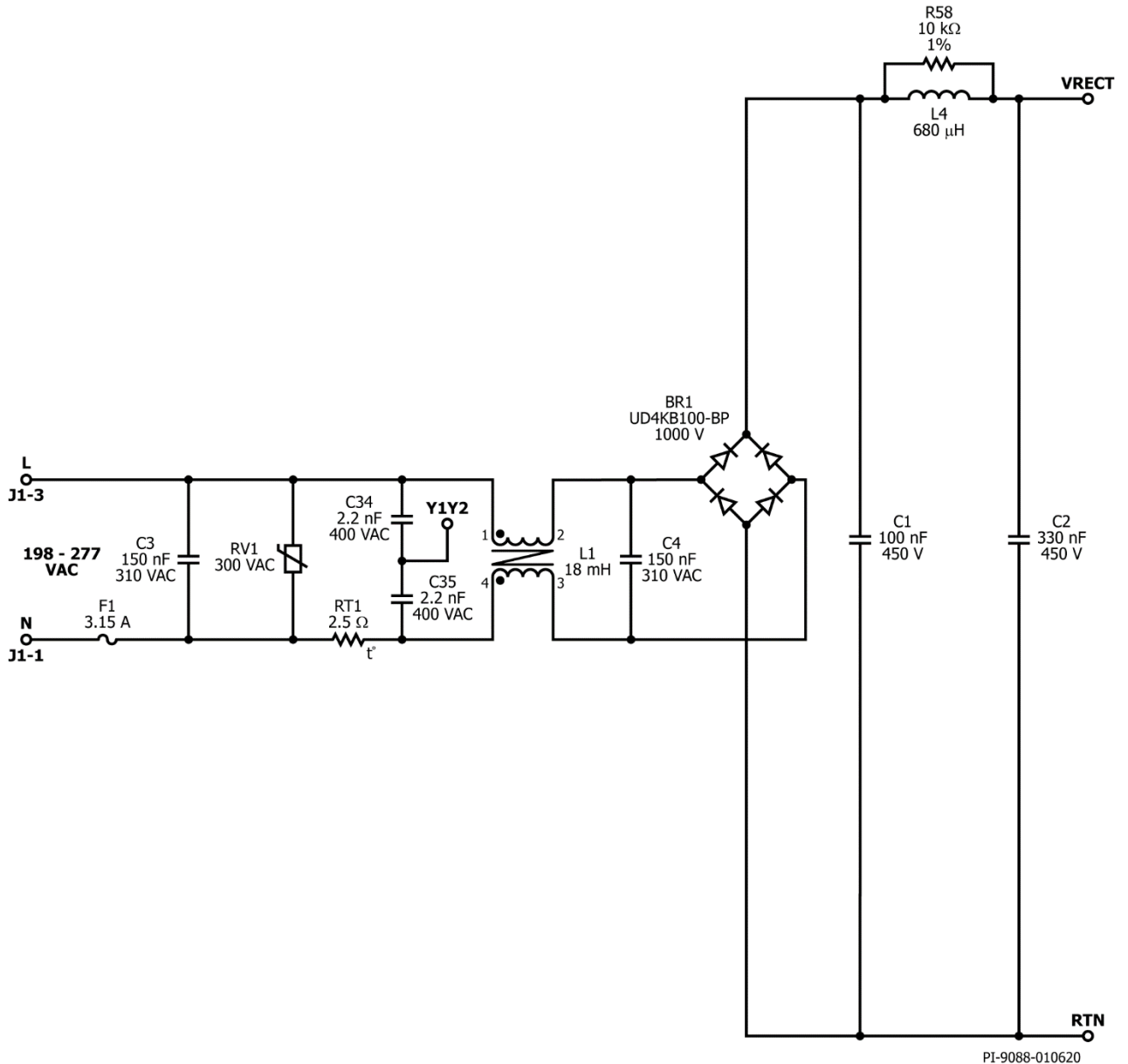
HiperPFS-4 PFS7623C is a PFC controller with an integrated power MOSFET and external boost diode. This stage is intended as a general purpose platform that operates from 198 VAC to 265 VAC input voltage that provides a highly efficient single-stage power factor corrector regulated at 410 V DC output voltage and continuous output power of 46 W.

The LYTSwitch-6 IC incorporates the primary FET, the primary-side controller and a secondary-side synchronous rectification controller. This IC also includes an innovative new technology, FluxLink™, which safely bridges the isolation barrier and eliminates the need for an optocoupler.

### 4.1 *Input EMI Filter and Rectifier*

The input fuse F1 provides safety protection. Varistor RV1 acts as a voltage clamp that limits the voltage spike on the primary during line transient voltage surge events. A 300 V rated part was selected, being above the maximum specified operating input voltage (265 V). The AC input voltage is full wave rectified by BR1 to achieve good power factor and low THD. Capacitors C1, C2 and L4 form a pi filter which together with C3 and C4 suppresses differential mode noise. Common mode noise is suppressed by common mode choke L1 together with Y capacitor C34 and C35. Additional Y capacitors C37 and C38 were added for earth wire connection to suppress common mode noise.

4.2 **First Stage: Boost PFC Using HiperPFS-4**



**Figure 5** – Input Schematic.

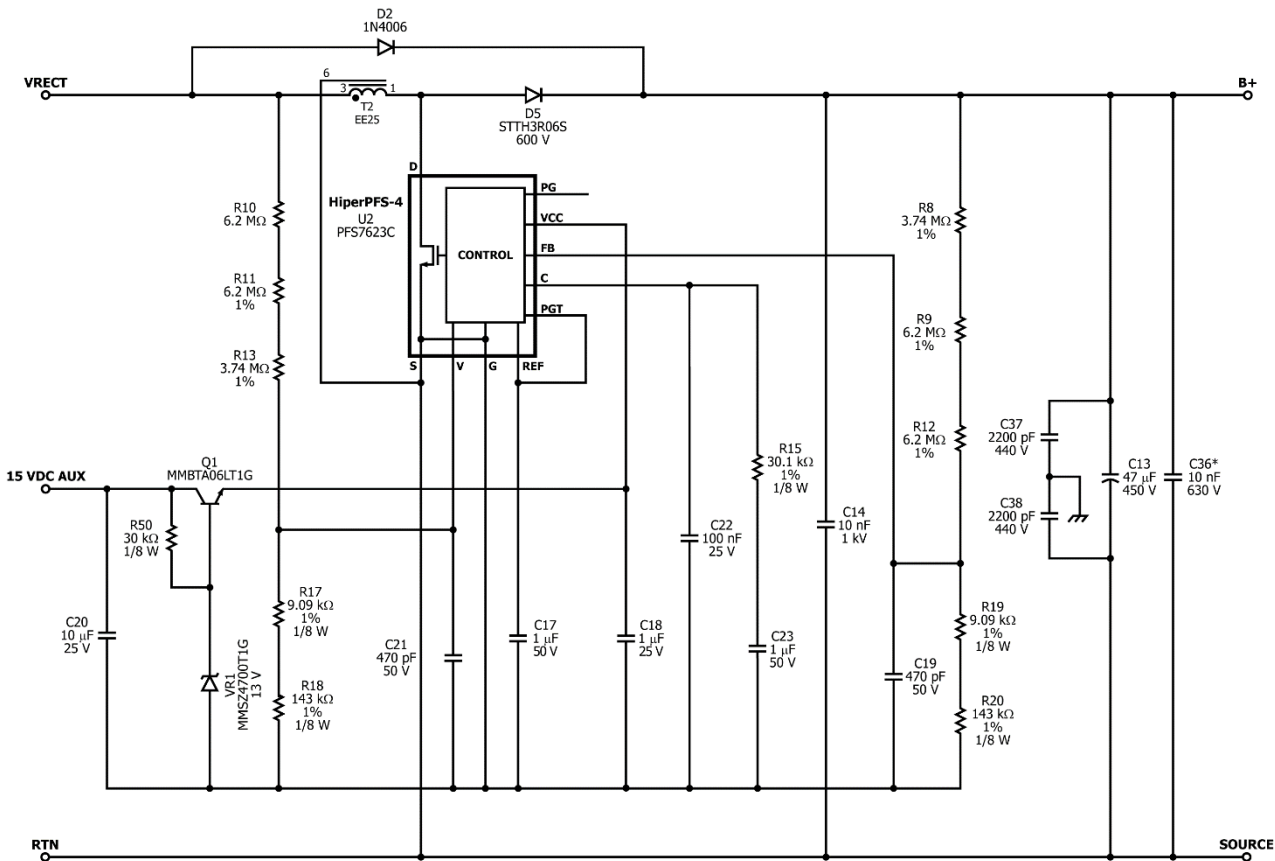


Figure 6 – PFC Schematic.

PI-9089-010720

The boost converter stage consists of the boost inductor T2 and the HiperPFS-4 PFS7623C IC U2. This converter stage operates as a PFC boost converter, thereby maintaining a sinusoidal input current to the power supply while regulating the output DC voltage. On the other hand, boost diode D5 is an STTH3R06S for cost effective solution with balanced EMI and switching speed performance.

Diode D2 provides an initial path for the inrush current at start up. This is important as a way to bypass the switching inductor T2 and switch U2 in order to prevent a resonant interaction between the boost inductor and output bulk capacitor C13. The IC is then powered on the VCC pin by an external bias from the T4. This external bias provides a 20 V DC, which is then regulated by Q1, R50 and VR1 to around 12 V DC.

Capacitor C14 provides a short, high-frequency return path to RTN. This effectively improves EMI results and reduces U2 MOSFET Drain voltage overshoot during turn off. Capacitor C17 is used to select the power mode of the IC. 1  $\mu$ F was used for full power mode. Capacitor C22, C23 and R15 for the loop compensation network required to tailor the loop response to ensure low cross-over frequency and sufficient phase margin. Its recommended values are 100 nF, 1  $\mu$ F and 30.1 k $\Omega$  respectively.



Resistor R8, R9, R12, R19 and R20 form the resistor network for the feedback. Voltage at feedback must be typically at 3.85 V with 3.82 V at its minimum. Resistor R10, R11, R13, R17 and R18 comprise the functionality for the VOLTAGE MONITOR (V) pin. This minimizes power dissipation and standby power consumption. This also features brown-in/out detection thresholds and incorporates a weak current source that acts as a pull-down in the event of an open circuit condition.

4.3 **Second Stage: Isolated Flyback DC-DC Using LYTSwitch-6**

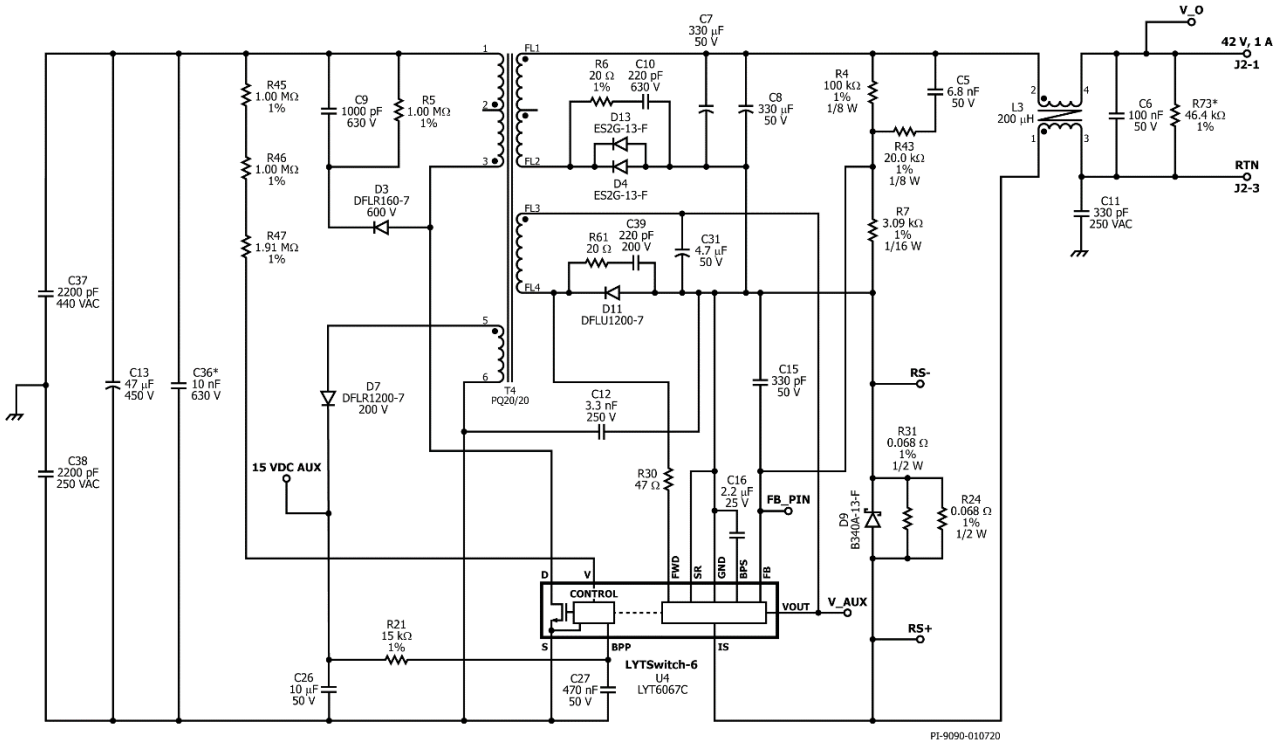


Figure 7 – Isolated Flyback DC-DC Schematic.



The second stage circuit topology is a flyback DC-DC power supply controlled by the LYTSwitch-6 IC. One side of the transformer (T4) primary is connected to the positive output terminal of the PFC while the other side is connected to the integrated 650 V power MOSFET inside the LYTSwitch-6 IC (U4). A low cost RCD clamp formed by D3, R5 and C9 limits the peak Drain voltage spike across U4 at the instant turn-off of the MOSFET. The clamp helps dissipate the energy stored in the leakage reactance of transformer T4.

The VOLTAGE MONITOR (V) pin of the LYTSwitch-6 IC is connected to the positive of the bulk capacitor (C13) to provide input voltage information. The voltage across the bulk capacitor (C13) is sensed and converted into current through V pin resistors R45, R46 and R47 to provide detection of overvoltage. These resistors detect an overvoltage of 441 V which is between the DC output of the 1<sup>st</sup> stage (410 V) and the bulk capacitor rating (450 V). The  $I_{OV}$  determines the input overvoltage threshold.

The IC is kick-started by an internal high-voltage current source that charges the BPP pin capacitor C27 when AC is first applied. Primary-side will listen for secondary request signals for around 82 ms. After initial power up, primary-side assumes control first and requires a handshake to pass the control to the secondary-side. During normal operation the primary-side block is powered from an auxiliary winding on the transformer. The output of this winding is rectified and filtered using diode D7 and capacitor C26. Resistor R21 limits the current being supplied to the BPP pin of the LYTSwitch-6 (U4). This auxiliary winding also powers the IC in the first stage.

The secondary-side control of the LYTSwitch-6 IC provides output voltage, output current sensing. The secondary winding of the transformer is rectified by D4, D13 and filtered by the output capacitors C7 and C8. Adding an RC snubber (R6 and C10) across the output diode reduces voltage stress across it.

The secondary-side of the IC is powered from an auxiliary winding FL3 and FL4. During constant voltage mode operation, output voltage regulation is achieved by sensing the output voltage via divider resistors R4 and R7. The voltage across R7 is fed into the FB pin with an internal reference voltage threshold of 1.265 V. Filter capacitor C15 is added across R7 to eliminate unwanted noise. This noise might trigger the OVP function or might increase the output ripple voltage.

During constant current operation, the output current is set by the sense resistors R31 and R24 across the IS pin and the GND pin. The internal reference threshold for the IS pin is 35.9 mV. Diode D9 in parallel with the current sense resistor serves as protection during output short-circuit conditions.

4.4 **PWM Dimming Circuit: 1% to 100%**

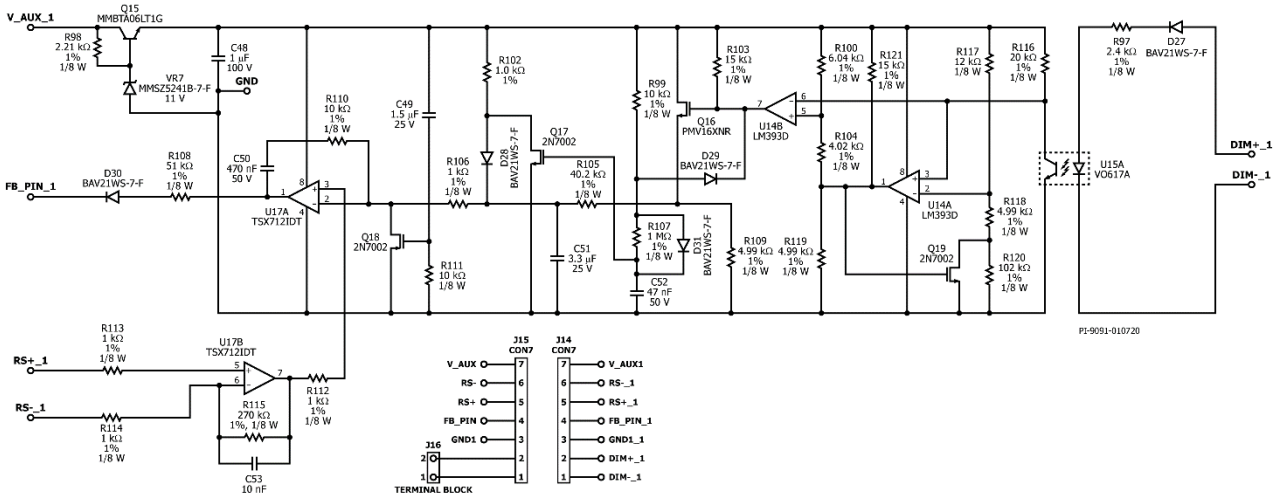


Figure 8 – PWM Dimming Control Schematic.

4.4.1 PWM Dimming Control Circuit Function

The PWM dimming control circuit basic function is sensing the output current, amplifying the signal and comparing it with a variable reference, and then injecting current into the FB pin to control the output load.

Output current is sensed through IS pin resistors R31 and R24. The output current passes through these resistors and the resulting voltage signal is then passed through the non-inverting amplifier circuit R113, R114, R115, U17B, and C53. The gain is set by R113 and R114 to 270 or about 9.5 V maximum. The output of the op-amp (pin 7) connects to the positive input (pin 3) through R112. The signal going to the negative input (pin 2) comes from the resulting DC signal from PWM dimming control (1%-100%, 300 Hz – 1 kHz). The averaging circuit composed of R105 and C51 converts the signal into DC before feeding to the op-amp input pin 2.

The basic principle of the circuitry is that the output at pin 7 of U17B will always try to match the voltage at pin 2 of U17A which is set by the dimming input. Since U17B is configured as a non-inverting op-amp and its input voltage signal is directly proportional to the output current, an increase in the voltage at pin 2 of U17A will result in an increase in the output current.

At start-up, the op-amp output is initially low which causes an unwanted spike in output current. To counter this effect, a blanking circuit Q18, R111, and C49 is added which initially pulls the inverting input (pin 2) down and in turn results to op-amp output high. The op-amp output (pin 1) is connected to the FB pin through D30 and R108. Depending on the op-amp output, current is injected into the FB pin. The feedback voltage will go up as current is injected. This will normally bring the output voltage down in CV mode. However, since the LED load is a constant voltage, it can't bring the voltage down.



Instead, the output current goes down as a consequence. The current injection loop has to be slow enough in order not to trigger feedback overvoltage protection when doing a step load from 100% to 1%. This is done by increasing the value of R108.

The operational amplifier U17 is powered by the secondary winding FL3 and FL4 through a linear regulator Q15, R98, VR7, and C48 with a 10 V DC rail output. This 10 V also supplies the output optocoupler, comparators, and other dimming components. The optocoupler (U15) output is set at 10V PWM signal for a better dimming resolution (e.g. 1% ~ 0.1 V, 100% ~ 10 V across C51).

A low-input offset operational amplifier is also recommended to reduce unit-to-unit variability. It is also important to place the dimming circuit close to the IS pin and FB pin to prevent noise from disturbing the loop.

#### 4.4.2 How the Dimming Control Circuit Works

The PWM dimming input signal can be an isolated signal or a standalone PWM module which provides a 5 V PWM variable duty cycle 1% to 100%, at 300 Hz up to 1 kHz frequency, with around 2 mA supply. The objective of the dimming control circuit is to deliver 1% to 100% dimming ratio output. When there is no PWM signal or at 0% duty cycle, the output load should be at 100%. This is similar to the non-dimming function of the circuit.

The optocoupler U15 (VO617A) serves as an isolation when the PWM module is referenced to the primary or external ground. The optocoupler output is fed to the inverting input of the comparator U14B, while the output of U14B (pin 7) is then fed to a buffer circuit composed of Q16, R103, and R109. In this way, the PWM input is always in-phase with the output on the drain of Q16. The optocoupler output is also fed to the non-inverting input of the comparator U14A. The additional comparator U14A (secondary reference voltage) helps to minimize the tolerance to  $\pm 2$  mA when dimming at 1% duty cycle or at around 10 mA output (8 mA to 12 mA). By creating a secondary reference voltage, the duty cycle or on-time of the output PWM is controlled by the comparators.

The comparators are primarily used to eliminate the delay in rise-time or fall-time of optocoupler output; especially when its CTR (current transfer ratio) is affected by high temperature or when the device operates outside the optimized CTR curve. This delay causes a change in output duty cycle of PWM at optocoupler output.

MOSFET Q16 used a low  $R_{DS(ON)}$  MOSFET (PMV16XNR) to eliminate the effect of the output saturation voltage of the comparator (during 1% dimming) when its output is directly fed to the RC averaging network (R105 and C51).

The design should ensure that Q17 is ON during  $1\% \leq \text{Duty} \leq 100\%$ , and it should turn OFF when there is no PWM input. When the PWM signal is OFF or at 0% duty cycle, the output load should be at 100%.



#### 4.4.2.1 When PWM Input Goes HIGH

The optocoupler output signal ( $V_{OUT\_OPTO}$ ) goes LOW at a certain fall-time (see Figure 8). This signal is fed both to non-inverting pin 3 and inverting pin 6 of U14.

- $V_{OUT\_OPTO} > 6\text{ V}$

Output pin 1 is HIGH and acts as an open collector: enables R119, drives Q19 to saturation which shorts R120 to GND (reference voltage at inverting pin 2 is at 3 V). When the optocoupler output starts to conduct, inverting pin 6 of U14B is pulled below 6 V (the reference voltage set by R100, R104, R119, at pin 5).

- $3\text{ V} < V_{OUT\_OPTO} < 6\text{ V}$

The output pin 7 is HIGH, driving Q16 into saturation, and charging C51 through R105 from the 10 V DC rail. Diode D29 is reverse-biased while D31 is forward-biased charging C52 via R99 from the 10 V rail, keeping Q17 in ON state. Diode D28 is reverse-biased since its anode is pulled to GND by Q17. Diode D28 must be a low-leakage diode so that it won't discharge C51.

The non-inverting pin 3 is pulled below 3 V (reference voltage set by R117 and R118 only).

- $V_{OUT\_OPTO} < 3\text{ V}$

The output of U14 at pin 1 is out of phase (LOW) while the output at pin 7 is in phase (HIGH) with the PWM input signal.

#### 4.4.2.2 When PWM Input Goes LOW

The optocoupler output ( $V_{OUT\_OPTO}$ ) will be non-conducting or will start to rise to 10 V from the DC rail, fed both to non-inverting pin 3 and inverting pin 6 of U14.

- $V_{OUT\_OPTO} < 4\text{ V}$

Output pin 1 is LOW: shorts R119 to GND, Q19 is OFF which enables R120. With R119 shorted to GND and R120 enabled, the reference voltage at pin 5 is set at 4 V and at pin 2 at 8 V.

The optocoupler output will not conduct, pulling pin 6 above 4 V (the reference voltage set by R100 and R104 only, at pin 5).

- $8\text{ V} > V_{OUT\_OPTO} > 4\text{ V}$

The output at pin 7 is LOW, turning OFF Q16. Capacitor C51 will discharge via R105 and R109. Diode D29 is forward-biased while D31 is reverse-biased, discharging C52 via R107. The voltage across C52 must not go below the  $V_{GS(TH)}$  of Q17 while pin 7 of U14B is LOW. Diode D28 is reverse-biased since its anode is pulled to GND by Q17. Diode D28 must be a low-leakage diode so that it won't discharge C51.

The non-inverting pin 3 is pulled above 8 V (reference voltage set by R117, R118 and R120).

- $V_{OUT\_OPTO} > 8\text{ V}$

The output at pin 1 is out of phase (HIGH) while the output at pin 7 is in phase (LOW) with the PWM input signal.

#### 4.4.2.3 Non-Dimming Function

The non-dimming function is enabled when the PWM input signal is OFF. The output should be at full-load or 100% output current. The non-dimming function is initiated by R102, D28, Q17, R107, C52, D31, and R99. The output of comparator U14B at pin 7 will be LOW for long period enough to discharge C52 below the  $V_{GS(TH)}$  of Q17. MOSFET Q17 will turn OFF. Diode D28 will turn ON and C51 will be charged via R102 from the 10 V DC rail. The LED output will be at maximum, 1000 mA.

4.4.2.4 Actual Output Waveforms: Dimming Control Circuit Operation

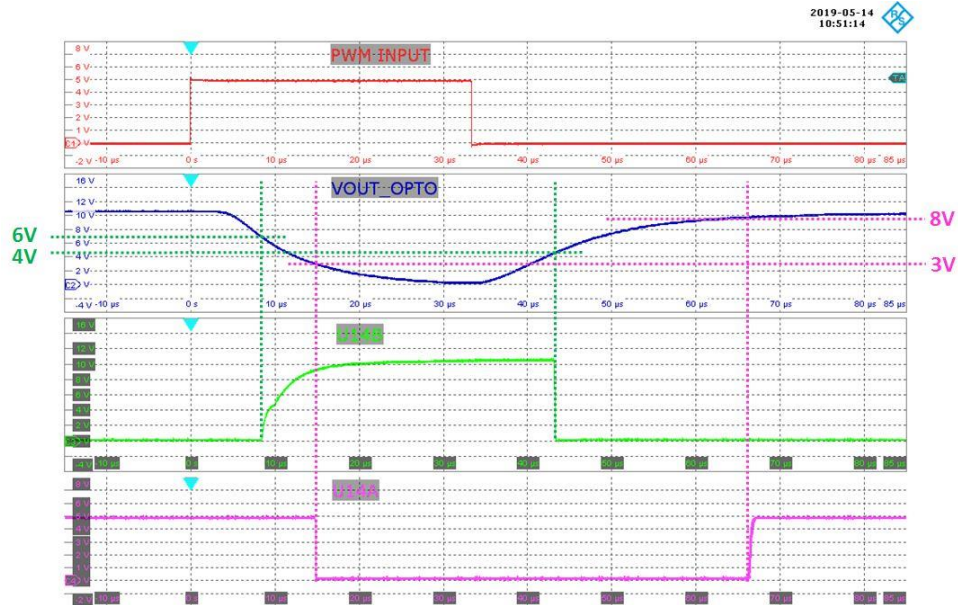


Figure 9 – Waveform of PWM Dimming Control Circuit with 5 V PWM Input 1% Duty Cycle at 300 Hz.

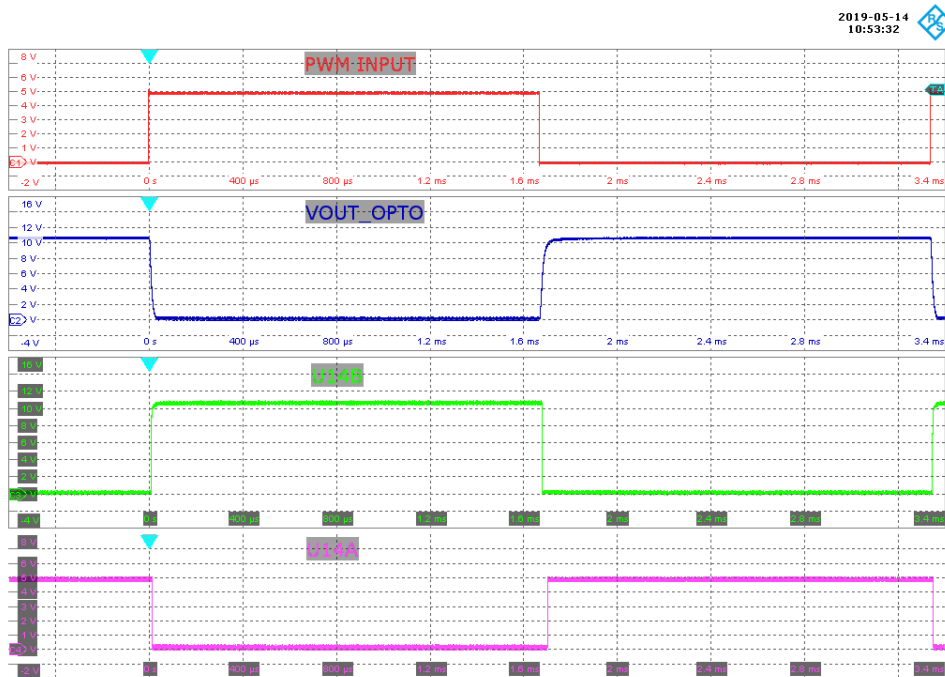


Figure 10 – Waveform of PWM Dimming Control Circuit with 5 V PWM Input 50% Duty Cycle at 300 Hz.

Note: Reference voltages set may not be the actual voltage due to component tolerance values.



### 5 PCB Layout

#### 5.1 Main Board Layout

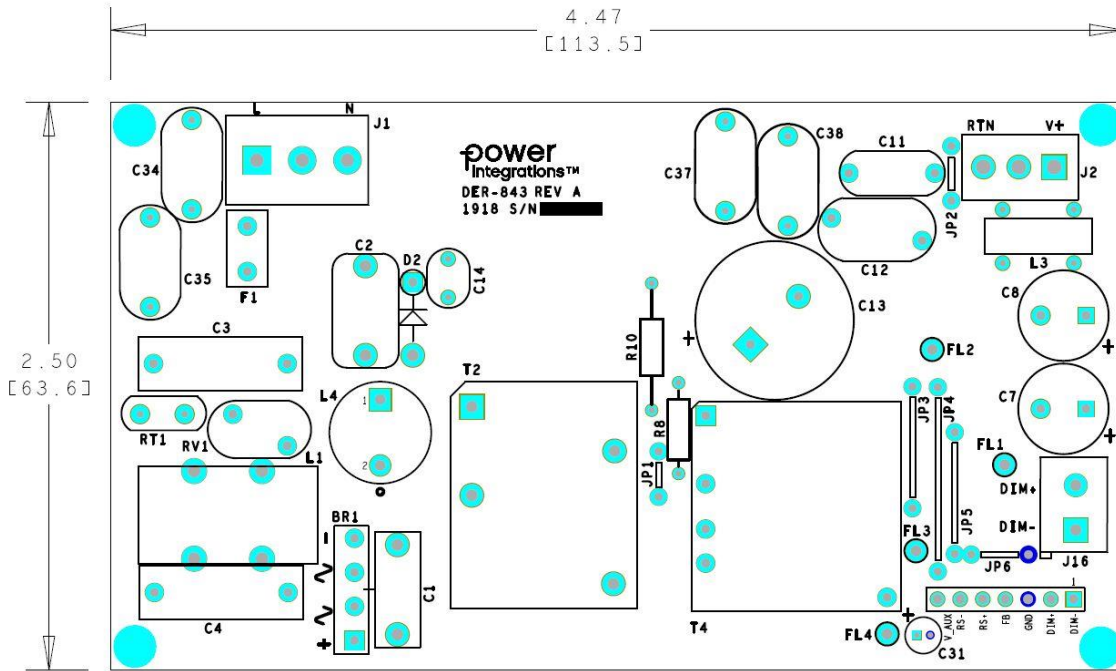


Figure 11 – PCB Top Side.

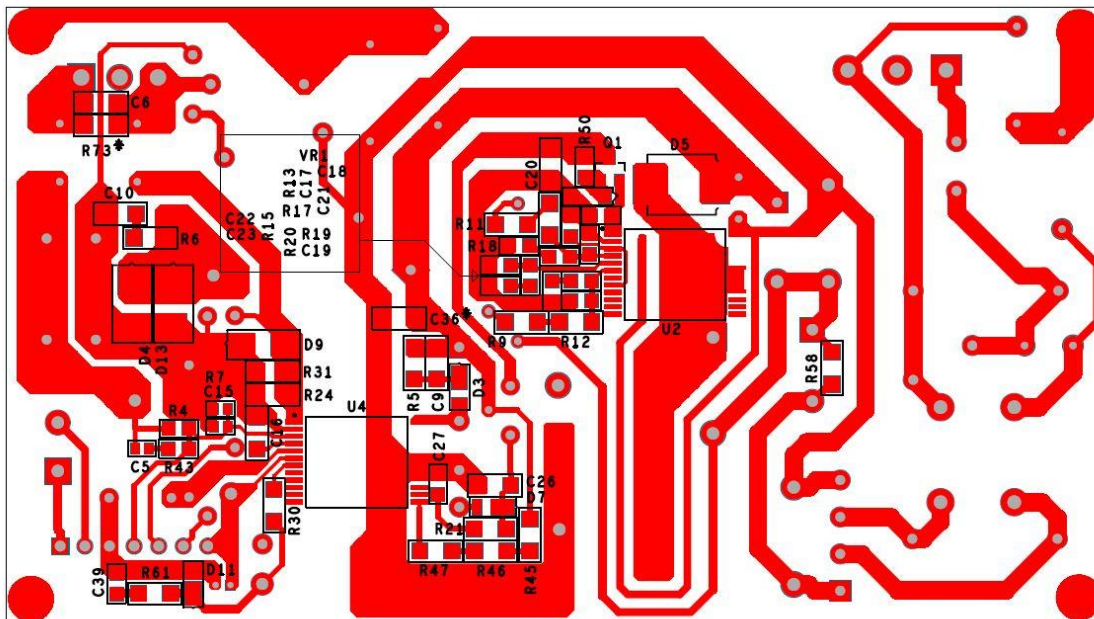


Figure 12 – PCB Bottom Side.



### 5.2 Dimming Circuit Board Layout

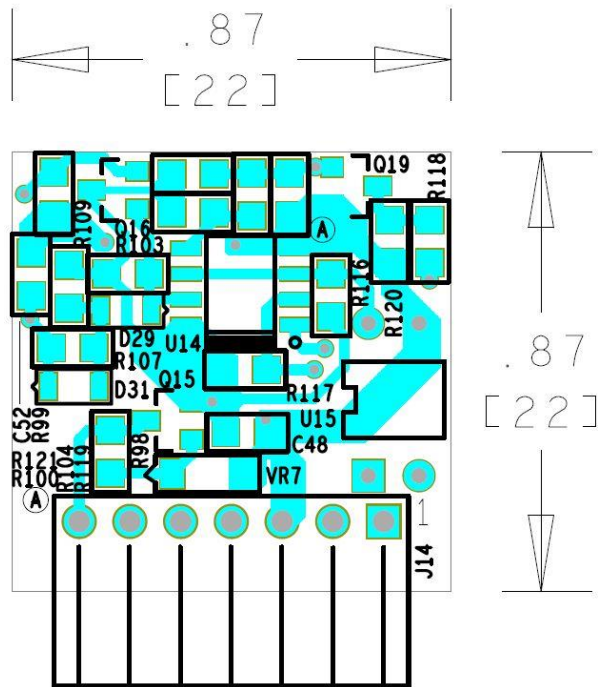


Figure 13 – PCB Top Side.

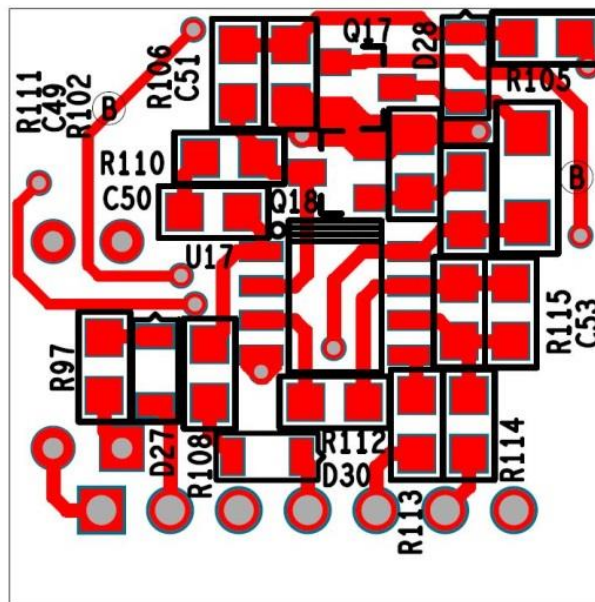


Figure 14 – PCB Bottom Side.



## 6 Bill of Materials

### 6.1 Main BOM

Item	Qty	Ref Des	Description	Mfg	Mfg Part Number
1	1	BR1	Bridge Rectifier, 1000 V, 4 A, 4-ESIP, D3K, -55°C ~ 150°C (TJ), Vf=1V @ 7.5A	UD4KB100-BP	Micro Commercial
2	1	C1	100 nF, 450 V, Polypropylene Film	ECW-F2W104JAQ	Panasonic
3	1	C2	330 nF, 450 V, METALPOLYPRO	ECW-F2W334JAQ	Panasonic
4	2	C3 C4	150 nF, 310 VAC, X2	BFC233820154	Vishay
5	1	C5	6.8 nF 50 V, Ceramic, X7R, 0603	CC0603KRX7R9BB682	Yageo
6	1	C6	100 nF, 50 V, Ceramic, X7R, 1206	CC1206KRX7R9BB104	Yageo
7	2	C7 C8	330 µF, ALUM, 20%, 50 V, RADIAL, 10000 Hrs @ 105°C, 0.394" Dia (10.00 mm), 0.866" Height (22.00 mm), 0.197" LS (5.00 mm)	UHW1H331MPD	Nichicon
8	1	C9	1000 pF, 630 V, Ceramic, X7R, 1206	C1206C102KBRCTU	Kemet
9	1	C10	220 pF, 630 V, Ceramic, NPO, 1206	C3216C0G2J221J	TDK
10	1	C11	330 pF, Ceramic Y1	440LT33-R	Vishay
11	1	C12	3.3 nF, Ceramic, Y1	440LD33-R	Vishay
12	1	C13	47 µF, 20%, 450 V, Electrolytic, 10000 Hrs @ 105°C, (18 x 20)	450BXW47MEFR18X20	Rubycon
13	1	C14	10 nF, 1 kV, Disc Ceramic, X7R	SV01AC103KAR	AVX
14	1	C15	330 pF 50 V, Ceramic, X7R, 0603	CC0603KRX7R9BB331	Yageo
15	1	C16	2.2 µF, 25 V, Ceramic, X7R, 1206	TMK316B7225KL-T	Taiyo Yuden
16	3	C17 C18 C23	1 µF, ±10%, 50 V, Ceramic, X7R, AEC-Q200, Automotive, Boardflex Sensitive, 0805, -55°C ~ 125°C	CGA4J3X7R1H105K125AE	TDK
17	2	C19 C21	470 pF, 50 V, Ceramic, X7R, 0805	CC0805KRX7R9BB471	Yageo
18	1	C20	10 µF, 25 V, Ceramic, X7R, 1206	C3216X7R1E106M160AB	TDK
19	1	C22	100 nF, 25 V, Ceramic, X7R, 0805	08053C104KAT2A	AVX
20	1	C26	10 µF, 10%, 50 V, Ceramic, X7R, -55°C ~ 125 °C, 1206, 0.126" L x 0.063" W (3.20 mm x 1.60 mm)	CL31B106KBHNNNE	Samsung
21	1	C27	470 nF, ±10%, 50 V, Ceramic, X7R, 0805	CL21B474KBFVPNE	Samsung
22	1	C31	4.7 µF Alum 20% 50 V RADIAL	EEA-GA1H4R7H	Panasonic
23	2	C34 C35	2200 PF Ceramic 500 VAC Y5V RADIAL	VY1222M37Y5VQ63V0	Vishay
24	1	C36	10 nF, 630 V, Ceramic, X7R, 1206	C1206C103KBRCTU	Kemet
25	2	C37 C38	2200 pF, Ceramic ±20%, 440 VAC, X1, Y1, Radial, Disc, 0.472" Dia (12.00 mm), 0.433" 0.630" (16.00 mm), LS 0.394" (10.00 mm)	KJN222MQ47FAFZA	KEMET
26	1	C39	220PF Ceramic 200 V X7R 0805	C0805C221K2RACTU	KEMET
27	1	D2	800 V, 1 A, GP, Rectifier, DO-41	1N4006-E3/54	Vishay
28	1	D3	600 V, 1 A, Rectifier, Glass Passivated, POWERDI123	DFLR1600-7	Diodes, Inc.
29	2	D4 D13	400 V, 2 A, Superfast, 35 ns, DO-214A, SMB	ES2G-13-F	Diodes, Inc.
30	1	D5	600 V, 3 A, SMC, DO-214AB	STTH3R06S	ST Micro
31	1	D7	200 V, 1 A, Rectifier, Glass Passivated, POWERDI123	DFLR1200-7	Diodes, Inc.
32	1	D9	DIODE, SCHOTTKY, 40 V, 3 A, SMA, DO-214AA	B340A-13-F	Diodes, Inc.
33	1	D11	DIODE, UFAST, 200 V, 1 A, POWERDI123	DFLU1200-7	Diodes, Inc.
34	1	F1	3.15 A, 250V, Slow, RST	507-1181	Belfuse
35	1	L1	18 mH, Input CMC, custom DER 750. Built with Toroid Core: 30-00398-00 and Magnet Wire: #26 AWG. Pinout now 1-2, 4-3	30-04100-00	Power Integrations



36	1	L3	200 $\mu$ H, Toroidal CMC, custom, DER-742,OUTPUT (L4), Wound on Toroid Core: PI #32-00315-00 (Bipolar Electronics TW GL50 T 12X6X4-C or equivalent)	32-00373-00	Power Integrations
37	1	L4	680 $\mu$ H, 0.8 A, 20%	RL-5480-4-680	Renco
38	1	Q1	NPN, Small Signal BJT, 80 V, 0.5 A, SOT-23	MMBTA06LT1G	On Semi
39	1	R4	RES, 100 k $\Omega$ , 1%, 1/8 W, Thick Film, 0805	ERJ-6ENF1003V	Panasonic
40	3	R5 R45 R46	RES, 1.00 M $\Omega$ , 1%, 1/4 W, Thick Film, 1206	ERJ-8ENF1004V	Panasonic
41	1	R6	RES, 20 $\Omega$ , 1%, 1/4 W, Thick Film, 1206	ERJ-8ENF20R0V	Panasonic
42	1	R7	RES, 3.09 k $\Omega$ , 1%, 1/16 W, Thick Film, 0603	ERJ-3EKF3091V	Panasonic
43	1	R8	RES, 3.74 M $\Omega$ , 1%, 1/4 W, Metal Film	MFR-25FBF52-3M74	Yageo
44	3	R9 R11 R12	RES, 6.2 M $\Omega$ , 1%, 1/4 W, Thick Film, 1206	KTR18EZPF6204	Rohm Semi
45	1	R10	RES, 6.2 M $\Omega$ , 5%, 1/4 W, Carbon Film	CFR-25JB-6M2	Yageo
46	1	R13	RES, 3.74 M $\Omega$ , 1%, 1/4 W, Thick Film, 1206	CRCW12063M74FKEA	Vishay
47	1	R15	RES, 30.1 k $\Omega$ , 1%, 1/8 W, Thick Film, 0805	ERJ-6ENF3012V	Panasonic
48	2	R17 R19	RES, 9.09 k $\Omega$ , 1%, 1/8 W, Thick Film, 0805	ERJ-6ENF9091V	Panasonic
49	2	R18 R20	RES, 143 k $\Omega$ , 1%, 1/8 W, Thick Film, 0805	ERJ-6ENF1433V	Panasonic
50	1	R21	RES, 15.0 k $\Omega$ , 1%, 1/4 W, Thick Film, 1206	ERJ-8ENF1502V	Panasonic
51	2	R24 R31	RES, SMD, 0.068, 68 m $\Omega$ , $\pm$ 1%, 0.5 W, 1206, Automotive AEC-Q200, Current Sense, Moisture Resistant Thick Film	RL1206FR-7W0R068L	Yageo
52	1	R30	RES, 47 $\Omega$ , 5%, 1/4 W, Thick Film, 1206	ERJ-8GEYJ470V	Panasonic
53	1	R43	RES, 20 k $\Omega$ , 1%, 1/8 W, Thick Film, 0805	ERJ-6ENF2002V	Panasonic
54	1	R47	RES, 1.91 M $\Omega$ , 1%, 1/4 W, Thick Film, 1206	RMCF1206FT1M91	Stackpole
55	1	R50	RES, 30 k $\Omega$ , 5%, 1/8 W, Thick Film, 0805	ERJ-6GEYJ303V	Panasonic
56	1	R58	RES, 10.0 k $\Omega$ , 1%, 1/4 W, Thick Film, 1206	ERJ-8ENF1002V	Panasonic
57	1	R61	RES, 20 $\Omega$ , 5%, 1/4 W, Thick Film, 1206	ERJ-8GEYJ200V	Panasonic
58	1	R73	RES, 46.4 k $\Omega$ , 1%, 1/4 W, Thick Film, 1206	ERJ-8ENF4642V	Panasonic
59	1	RT1	NTC Thermistor, 2.5 $\Omega$ , 3 A	SL08 2R503	Ametherm
60	1	RV1	300 VAC, 25 J, 7 mm, RADIAL	V300LA4P	Littlefuse
61	1	T2	Bobbin, EE25, Vertical, 10 pins	YW-360-02B	Yih-Hwa
62	1	T4	Bobbin, PQ20/20, Vertical, 14 pins	CPV-PQ20/20-1S14PZ	Ferroxcube
63	1	U2	HiperPFS-4, InSOP24B	PFS7623C	Power Integrations
64	1	U4	LYTSwitch-6 Integrated Circuit, InSOP24D	LYT6067C	Power Integrations
65	1	VR1	13 V, 5%, 500 Mw, SOD-123	MMSZ4700T1G	ON Semi

6.2 **Dimming Board BOM**

Item	Qty	Ref Des	Description	Mfg	Mfg Part Number
1	1	C48	1 $\mu$ F, 100 V, Ceramic, X7S, 0805	C2012X7S2A105K125AB	TDK
2	1	C49	1.5 $\mu$ F, 25V, Ceramic, X7R, 0805	C2012X7R1E155M125AC	TDK
3	1	C50	470 nF, $\pm$ 10%, 50 V, Ceramic, X7R, 0805	CL21B474KBFVPNE	Samsung
4	1	C51	3.3 $\mu$ F, 25 V, Ceramic, X7R, 0805	C2012X7R1E335K	TDK
5	1	C52	0.047 $\mu$ F Ceramic 50 V X7R 0805	CC0805KRX7R9BB473	Yageo
6	1	C53	10 nF, 50 V, Ceramic, X7R, 0805	C0805C103K5RACTU	Kemet
7	5	D27 D28 D29 D30 D31	250 V, 0.2 A, Fast Switching, 50 ns, SOD-323	BAV21WS-7-F	Diodes, Inc.
8	2	J14 J15	7 Position (1 x 7) header, 0.1 pitch, R/A Tin	22-12-2071	Molex
9	1	J16	CONN TERM BLOCK, 2 POS, 5mm, PCB	ED500/2DS	On Shore Tech
10	1	Q15	NPN, Small Signal BJT, 80 V, 0.5 A, SOT-23	MMBTA06LT1G	On Semi
11	1	Q16	MOSFET, N-CH, 20V, SOT23	PMV16XNR	NXP Semi
12	3	Q17 Q18 Q19	60 V, 115 mA, SOT23-3	2N7002-7-F	Diodes, Inc.
13	1	R97	RES, 2.4 k $\Omega$ , 5%, 1/8 W, Thick Film, 0805	ERJ-6GEYJ242V	Panasonic
14	1	R98	RES, 2.21 k $\Omega$ , 1%, 1/8 W, Thick Film, 0805	ERJ-6ENF2211V	Panasonic
15	2	R99 R111	RES, 10 k $\Omega$ , 5%, 1/8 W, Thick Film, 0805	ERJ-6GEYJ103V	Panasonic
16	1	R100	RES, 6.04 k $\Omega$ , 1%, 1/8 W, Thick Film, 0805	ERJ-6ENF6041V	Panasonic
17	1	R102	RES, 1.0 k $\Omega$ , 1%, 1/4 W, Thick Film, 1206	ERJ-8ENF1001V	Panasonic
18	2	R103 R121	RES, 15 k $\Omega$ , 1%, 1/8 W, Thick Film, 0805	ERJ-6ENF1502V	Panasonic
19	1	R104	RES, 4.02 k $\Omega$ , 1%, 1/8 W, Thick Film, 0805	ERJ-6ENF4021V	Panasonic
20	1	R105	RES, 40.2 k $\Omega$ , 1%, 1/8 W, Thick Film, 0805	ERJ-6ENF4022V	Panasonic
21	4	R106 R112 R113 R114	RES, 1.00 k $\Omega$ , 1%, 1/8 W, Thick Film, 0805	ERJ-6ENF1001V	Panasonic
22	1	R107	RES, 1 M $\Omega$ , 1%, 1/8 W, Thick Film, 0805	ERJ-6ENF1004V	Panasonic
23	1	R108	RES, 51 K $\Omega$ , $\pm$ 1%, $\pm$ 100ppm/ $^{\circ}$ C, 1/8 W, Automotive AEC-Q200, Moisture Resistant, Thick Film, 0805	AC0805FR-0751KL	Yageo
24	3	R109 R118 R119	RES, 4.99 k $\Omega$ , 1%, 1/8 W, Thick Film, 0805	ERJ-6ENF4991V	Panasonic
25	1	R110	RES, 10 k $\Omega$ , 1%, 1/8 W, Thick Film, 0805	ERJ-6ENF1002V	Panasonic
26	1	R115	RES, 270 k $\Omega$ , 5%, 1/8 W, Thick Film, 0805	ERJ-6GEYJ274V	Panasonic
27	1	R116	RES, 20 k $\Omega$ , 1%, 1/8 W, Thick Film, 0805	ERJ-6ENF2002V	Panasonic
28	1	R117	RES, 12 k $\Omega$ , 5%, 1/8 W, Thick Film, 0805	ERJ-6GEYJ123V	Panasonic
29	1	R120	RES, 102 k $\Omega$ , 1%, 1/8 W, Thick Film, 0805	ERJ-6ENF1023V	Panasonic
30	1	U14	Dual Diff Comparator, 8-SOIC	LM393D	National
31	1	U15	Optoisolator, Transistor Output, 5300 Vrms, 1 Channel, 4-DIP	VO617A	Vishay
32	1	U17	IC, DUAL Op Amp, General Purpose, 2.7 MHz, Rail to Rail, 8-SOIC (0.154", 3.90 mm Width), 8-SO	TSX712IDT	ST Micro
33	1	VR7	Diode Zener 11 V 500 mW SOD123	MMSZ5241B-7-F	Diodes, Inc.

6.3 **Miscellaneous Parts**

Item	Qty	Ref	Description	Mfg Part Number	Mfg
1	1	J1	CONN TERM BLOCK 5.08 MM 3POS, Screw - Leaf Spring, Wire Guard	ED120/3DS	On Shore Tech
2	1	J2	3 Position (1 x 3) header, 0.156 pitch, Vertical	26-48-1031	Molex
3	1	JP1	Wire Jumper, Insulated, #24 AWG, 0.2 in	C2003A-12-02	Gen Cable
4	5	JP2 JP3 JP4 JP5 JP6	Wire Jumper, Insulated, #24 AWG, 0.3 in	C2003A-12-02	Gen Cable





## 7 PFC Inductor (T2) Specifications

### 7.1 Electrical Diagram

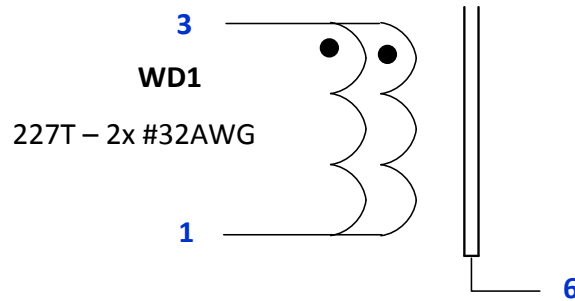


Figure 15 – Inductor Electrical Diagram.

### 7.2 Electrical Specifications

Parameter	Condition	Spec.
Nominal Primary Inductance	Measured at 1 V <sub>PK-PK</sub> , 100 kHz switching frequency, between pin 1 and pin 3, with all other windings open.	2722 $\mu$ H
Tolerance	Tolerance of Primary Inductance.	$\pm 5\%$

### 7.3 Material List

Item	Description
[1]	Core: EE25.
[2]	Bobbin, EE25, Vertical, 10 pin.
[3]	Magnet Wire: #32 AWG.
[4]	Polyester Tape: 8.7 mm.
[5]	Polyester Tape: 11 mm.
[6]	Copper Wire.

7.4 **Inductor Build Diagram**

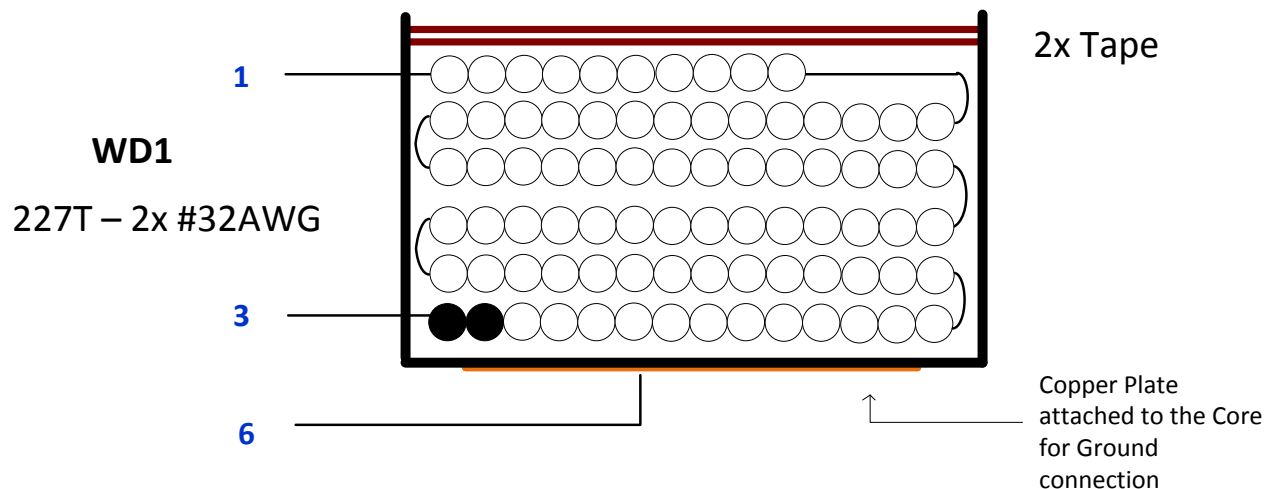
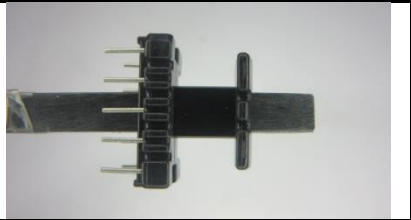
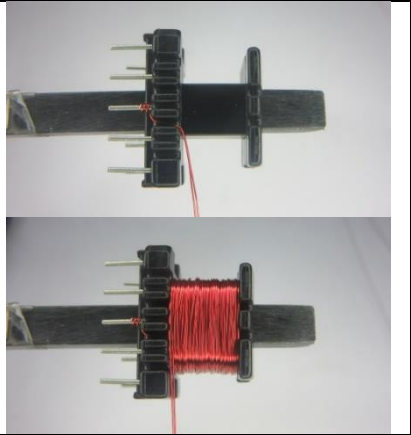
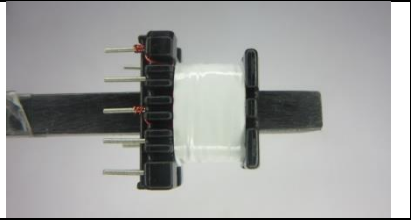
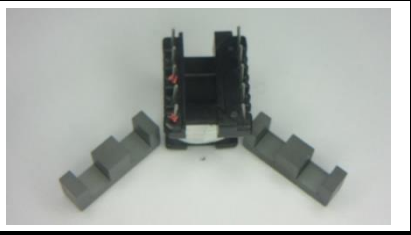

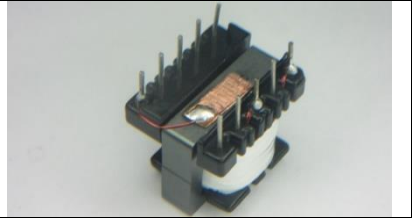


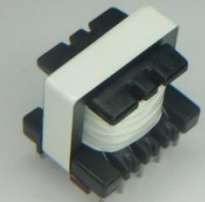

Figure 16 – Transformer Build Diagram.

7.5 **Inductor Construction**

<b>Winding Directions</b>	Bobbin is oriented on winder jig such that terminal pin 1-5 is on the left side. The winding direction is clockwise.
<b>Winding 1</b>	Use magnetic wire Item [3]. Prepare magnetic wire for bifilar wound. Start at pin 3 and wind 227 turns in bifilar wound then finish the winding on pin 1.
<b>Insulation</b>	Apply 1 layer of polyester tape, Item [5] for insulation.
<b>Core Grinding</b>	Grind the center leg of 1 core to meet the nominal inductance specification 2722 $\mu$ H.
<b>Assemble Core</b>	Assemble the 2 cores into the bobbin.
<b>Core Termination</b>	Prepare a copper strip with a soldered magnetic wire, Item [6], at the middle as shown in the picture. Apply copper strip at the bottom part of the core and terminate the magnetic wire on Pin 6.
<b>Bobbin Tape</b>	Add 2 layers of polyester tape Item [5] around the bobbin together with the core to fix the 2 cores.
<b>Pins</b>	Cut terminal pins 2, 4, 5, 7, 8, and 10.
<b>Finish</b>	Apply 2:1 varnish and thinner solution.

## 7.6 *Winding Illustrations*

<p><b>Winding Directions</b></p> <p>Bobbin is oriented on winder jig such that terminal pin 1-5 is on the left side. The winding direction is clockwise.</p>	
<p><b>Winding 1</b></p> <p>Use magnetic wire Item [3]. Prepare magnetic wire for bifilar wound. Start at pin 3 and wind 227 turns in bifilar wound then finish the winding on pin 1.</p>	
<p><b>Insulation</b></p> <p>Apply 1 layer of polyester tape, Item [5] for insulation.</p>	
<p><b>Core Grinding</b></p> <p>Grind the center leg of 1 core to meet the nominal inductance specification 2722 <math>\mu</math>H.</p>	
<p><b>Assemble Core</b></p> <p>Assemble the 2 cores into the bobbin</p>	
<p><b>Core Termination</b></p> <p>Prepare a copper strip with a soldered magnetic wire, Item [6], at the middle as shown in the picture. Apply copper strip at the bottom part of the core and terminate the magnetic wire on Pin 6.</p>	

<p><b>Bobbin Tape</b></p> <p>Add 2 layers of polyester tape Item [5] around the bobbin together with the core to fix the 2 cores.</p>	
<p><b>Pins</b></p> <p>Cut terminal pins 2, 4, 5, 7, 8, and 10.</p> <p><b>Finish</b></p> <p>Apply 2:1 varnish and thinner solution.</p>	

## 8 Flyback Transformer (T4) Specifications

### 8.1 Electrical Diagram

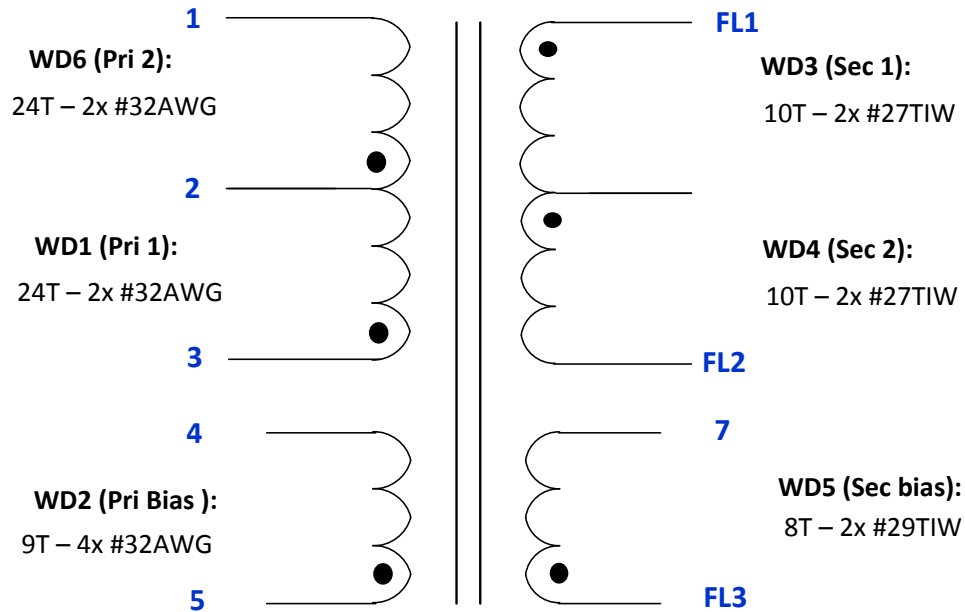


Figure 17 – Transformer Electrical Diagram.

### 8.2 Electrical Specifications

Parameter	Condition	Spec.
Nominal Primary Inductance	Measured at 1 V <sub>PK-PK</sub> , 100 kHz switching frequency, across pin 1 and pin 3, with all other windings open.	608 μH
Tolerance	Tolerance of Primary Inductance.	±5%
Leakage Inductance	Short all bias windings and secondary windings. Measured at 1 V <sub>PK-PK</sub> , 100 kHz switching frequency, across pin 1 and pin 3.	<5 μH

### 8.3 Material List

Item	Description
[1]	Core: PQ2020 Equivalent.
[2]	Bobbin: PQ2020, Vertical, 14 pin.
[3]	Primary Magnet Wire: #32 AWG.
[4]	Auxiliary Magnet Wire: #32 AWG.
[5]	Secondary Wire TIW: #27 AWG.
[6]	Auxiliary Wire TIW: #29 AWG.
[7]	Polyester Tape: 11.3 mm.
[8]	Polyester Tape: 9.3 mm.

8.4 **Transformer Build Diagram**

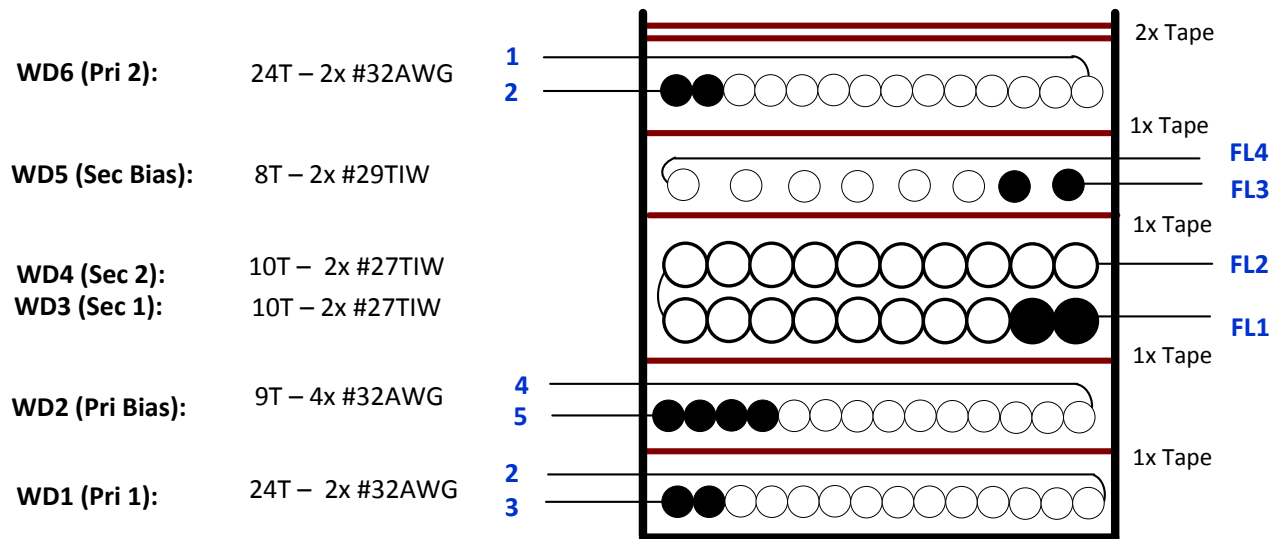
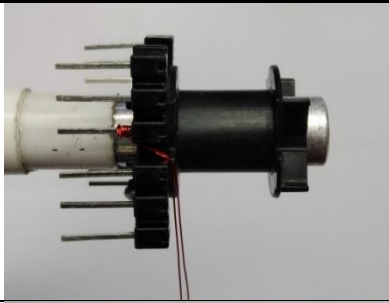
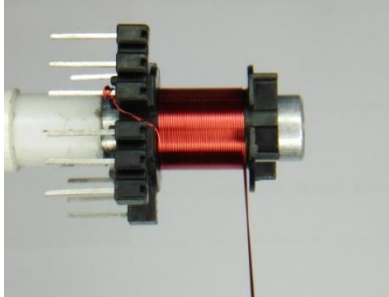



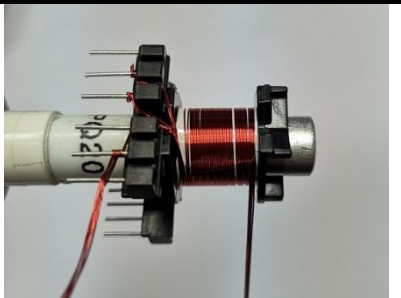
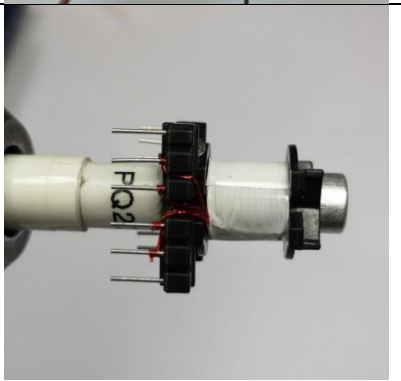
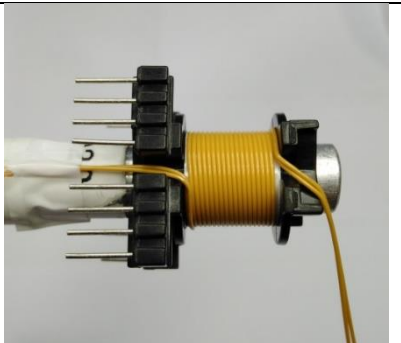
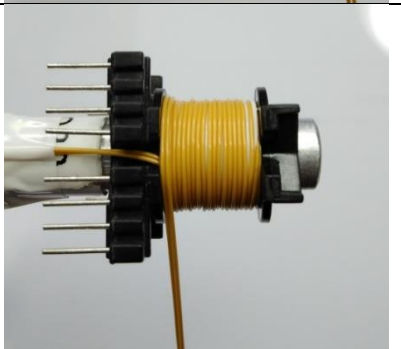
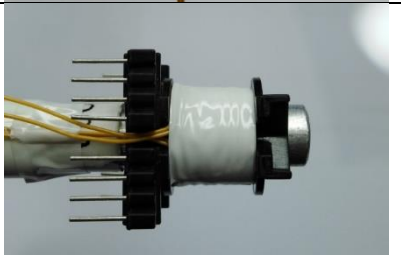
Figure 18 – Inductor Build Diagram.

8.5 **Transformer Construction**

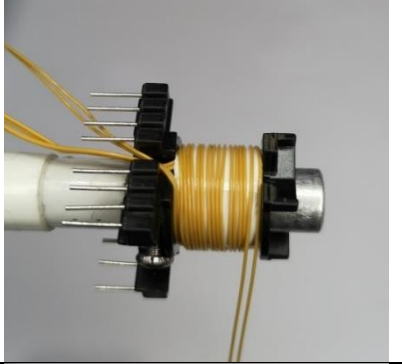
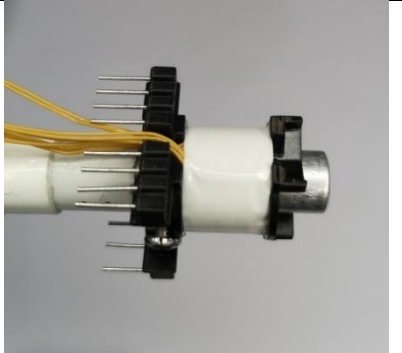
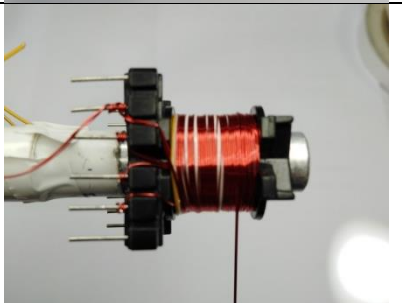
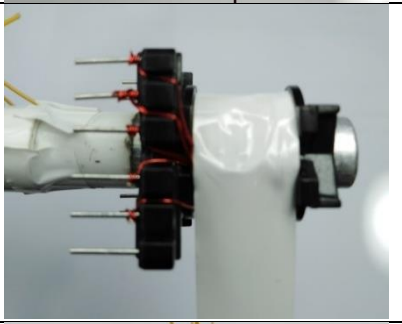
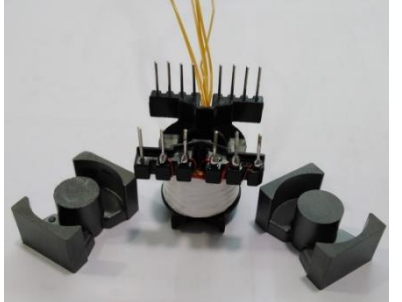
<b>Winding Directions</b>	Bobbin is oriented on winder jig such that terminal pin 1-6 is on the left side. The winding direction is clockwise.
<b>Winding 1</b>	Use magnetic wire Item [3]. Start at pin 3 and wind 24 turns evenly. Finish the winding on pin 2.
<b>Insulation</b>	Apply 1 layer of polyester tape, Item [7] for insulation.
<b>Winding 2</b>	Use 4-layer magnetic wire Item 4. Start at pin 5 and wind 9 turns evenly. Finish winding on pin 4.
<b>Insulation</b>	Apply 1 layer of polyester tape, Item [7] for insulation.
<b>Winding 3</b>	Use 2-layer triple insulated wire Item [5] with enough length for WD3 (10T) and WD4 (10T). Mark the Start terminal as FL1. Start at FL1 and wind 10 turns in 1 layer as shown in the figure. Do not cut the excess wire and reserve it for WD4.
<b>Winding 4</b>	Use excess wire from Winding 3. Wind 10 turns evenly. The finished terminal will be a fly wire mark as FL2.
<b>Insulation</b>	Apply 1 layer of polyester tape, Item [7] for insulation.
<b>Winding 5</b>	Use 2-layer triple-insulated wire Item [6]. Mark and start terminal at FL3 and wind 8 turns evenly. Finish and mark the winding at FL4.
<b>Insulation</b>	Apply 1 layer of polyester tape, Item [7] for insulation.
<b>Winding 6</b>	Use 2-layer magnetic wire Item [3]. Start at pin 2 and wind 24 turns evenly. Finish the winding on pin 1.
<b>Insulation</b>	Apply 2 layers of polyester tape, Item [7] for insulation.
<b>Core Grinding</b>	Grind the center leg of 1 core to meet the nominal inductance specification of 608 $\mu$ H.
<b>Assemble Core</b>	Assemble the 2 cores into the bobbin and secure with polyester tape item [8].
<b>Pins</b>	Cut terminal pins 6, 8 to 14 and half of pin 2.
<b>Apply Varnish</b>	Apply 2:1 varnish and thinner solution.

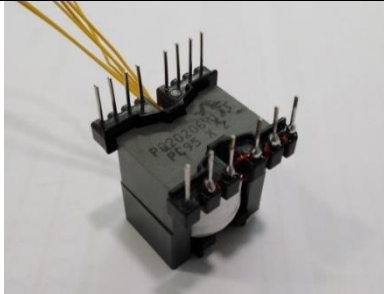
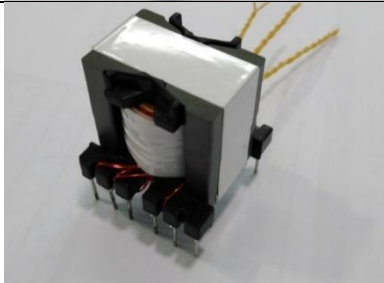
## 8.6 *Winding Illustrations*

<p><b>Winding Directions</b></p> <p>Bobbin is oriented on winder jig such that terminal pin 1-6 is on the left side. The winding direction is clockwise.</p>	
<p><b>Winding 1</b></p> <p>Use magnetic wire Item [3]. Start at pin 3 and wind 24 turns evenly. Finish the winding on pin 2.</p>	
<p><b>Insulation</b></p> <p>Apply 1 layer of polyester tape, Item [7] for insulation.</p>	

<p><b>Winding 2</b></p> <p>Use 4-layer magnetic wire Item 4. Start at pin 5 and wind 9 turns evenly. Finish winding on pin 4.</p>	
<p><b>Insulation</b></p> <p>Apply 1 layer of polyester tape, Item [7] for insulation.</p>	
<p><b>Winding 3</b></p> <p>Use 2-layer triple insulated wire Item [5] with enough length for WD3 (10T) and WD4 (10T). Mark the Start terminal as FL1. Start at FL1 and wind 10 turns in 1 layer as shown in the figure. Do not cut the excess wire and reserve it for WD4.</p>	
<p><b>Winding 4</b></p> <p>Use excess wire from Winding 3. Wind 10 turns evenly. The finished terminal will be a fly wire mark as FL2.</p>	
<p><b>Insulation</b></p> <p>Apply 1 layer of polyester tape, Item [7] for insulation.</p>	



<p><b>Winding 5</b></p> <p>Use 2-layer triple-insulated wire Item [6]. Mark and start terminal at FL3 and wind 8 turns evenly. Finish and mark the winding at FL4.</p>	
<p><b>Insulation</b></p> <p>Apply 1 layer of polyester tape, Item [7] for insulation.</p>	
<p><b>Winding 6</b></p> <p>Use 2-layer magnetic wire Item [3]. Start at pin 2 and wind 24 turns evenly. Finish the winding on pin 1.</p>	
<p><b>Insulation</b></p> <p>Apply 2 layers of polyester tape, Item [7] for insulation.</p>	
<p><b>Core Grinding</b></p> <p>Grind the center leg of 1 core to meet the nominal inductance specification of 608 <math>\mu</math>H.</p>	

<p><b>Assemble Core</b></p> <p>A Assemble the 2 cores into the bobbin and secure with polyester tape item [8].</p>	
<p><b>Pins</b></p> <p>Cut terminal pins 6, 8 to 14 and half of pin 2.</p> <p><b>Apply Varnish</b></p> <p>Apply 2:1 varnish and thinner solution.</p>	

## 9 PFC Boost Transformer Spreadsheet

1	Hiper_PFS-4_Boost_110818; Rev.1.2; Copyright Power Integrations 2018	INPUT	INFO	OUTPUT	UNITS	Continuous Mode Boost Converter Design Spreadsheet
2	<b>Enter Application Variables</b>					
3	Input Voltage Range	Universal		Universal		Input voltage range
4	VACMIN	180		180	VAC	Minimum AC input voltage. Spreadsheet simulation is performed at this voltage. To examine operation at other voltages, enter here, but enter fixed value for LPFC_ACTUAL.
5	VACMAX	264		264	VAC	Maximum AC input voltage
6	VBROWNIN		Info	84	VAC	Brown-IN voltage has been modified since the V-pin ratio is no longer 100:1
7	VBROWNOUT		Info	73	VAC	Brown-OUT voltage has been modified since the V-pin ratio is no longer 100:1
8	VO	410	Info	410	VDC	Brown IN/OUT voltage has changed due to modifications in the V-pin ratio from 100:1. Recommend Vpin ratio= FB pin ratio for optimized operation. Check the PF, input current distortion, brown in/out and power delivery
9	PO	44		44	W	Nominal Output power
10	fL			50	Hz	Line frequency
11	TA Max			40	°C	Maximum ambient temperature
12	Efficiency Estimate	0.95		0.95		Enter the efficiency estimate for the boost converter at VACMIN. Should approximately match calculated efficiency in Loss Budget section
13	VO_MIN			390	VDC	Minimum Output voltage
14	VO_RIPPLE_MAX	15		15	VDC	Maximum Output voltage ripple
15	T_HOLDUP			20	ms	Holdup time
16	VHOLDUP_MIN			328	VDC	Minimum Voltage Output can drop to during holdup
17	I_INRUSH			40	A	Maximum allowable inrush current
18	Forced Air Cooling	No		No		Enter "Yes" for Forced air cooling. Otherwise enter "No". Forced air reduces acceptable choke current density and core autpick core size
20	<b>KP and INDUCTANCE</b>					
21	KP_TARGET	0.70		0.70		Target ripple to peak inductor current ratio at the peak of VACMIN. Affects inductance value
22	LPFC_TARGET (0 bias)			2722	uH	PFC inductance required to hit KP_TARGET at peak of VACMIN and full load
23	LPFC_DESIRE (0 bias)		Info	2722	uH	Inductance too high: Core size will be too big
24	KP_ACTUAL			0.702		Actual KP calculated from LPFC_DESIRE
25	LPFC_PEAK			2722	uH	Inductance at VACMIN and maximum bias current. For Ferrite, same as LPFC_DESIRE (0 bias)
27	<b>Basic current parameters</b>					
28	IAC_RMS			0.26	A	AC input RMS current at VACMIN and Full Power load
29	IO_DC			0.11	A	Output average current/Average diode current
32	<b>PFS Parameters</b>					
33	PFS Package	C		C		HiperPFS package selection
34	PFS Part Number	Auto		PFS7623C		If examining brownout operation, over-ride autpick with desired device size
35	Operating Mode	Efficiency		Efficiency		Mode of operation of PFS. For Full Power mode enter "Full Power" otherwise enter "EFFICIENCY" to indicate efficiency mode
36	IOCP min			2.6	A	Minimum Current limit



37	IOCP typ			2.8	A	Typical current limit
38	IOCP max			3.0	A	Maximum current limit
39	IP			0.56	A	MOSFET peak current
40	IRMS			0.20	A	PFS MOSFET RMS current
41	RDSOn			0.87	Ohms	Typical RDSon at 100 °C
42	FS_PK			96.6	kHz	Estimated frequency of operation at crest of input voltage (at VACMIN)
43	FS_AVG			86.6	kHz	Estimated average frequency of operation over line cycle (at VACMIN)
44	PCOND_LOSS_PFS			0.033	W	Estimated PFS conduction losses
45	PSW_LOSS_PFS			1.014	W	Estimated PFS switching losses
46	PFS_TOTAL			1.047	W	Total Estimated PFS losses
47	TJ Max			100	deg C	Maximum steady-state junction temperature
48	Rth-JS			2.80	°C/W	Maximum thermal resistance (Junction to heatsink)
49	HEATSINK Theta-CA			54.49	°C/W	Maximum thermal resistance of heatsink
<b>52</b>	<b>INDUCTOR DESIGN</b>					
<b>53</b>	<b>Basic Inductor Parameters</b>					
54	LPFC (0 Bias)			2722	uH	Value of PFC inductor at zero current. This is the value measured with LCR meter. For powder, it will be different than LPFC.
55	LP_TOL			10.0	%	Tolerance of PFC Inductor Value (ferrite only)
56	IL_RMS			0.28	A	Inductor RMS current (calculated at VACMIN and Full Power Load)
57	Material and Dimensions					
58	Core Type	Ferrite		Ferrite		Enter "Sendust", "Iron Powder" or "Ferrite"
59	Core Material	PC44/PC95		PC44/PC95		Select from 60u, 75u, 90u or 125 u for Sendust cores. Fixed at PC44/PC95 for Ferrite cores. Fixed at -52 material for Pow Iron cores.
60	Core Geometry	EE		EE		Toroid only for Sendust and Powdered Iron; EE or PQ for Ferrite cores.
61	Core	EE25.4		EE25.4		Core part number
62	Ae	51.40		51.40	mm^2	Core cross sectional area
63	Le	57.80		57.80	mm	Core mean path length
64	AL	1250.00		1250.00	nH/t^2	Core AL value
65	Ve	2.97		2.97	cm^3	Core volume
66	HT (EE/PQ/EQ/RM/POT) / ID (toroid)	16.10		16.10	mm	Core height/Height of window; ID if toroid
67	MLT	36.8		36.8	mm	Mean length per turn
68	BW	4.01		4.01	mm	Bobbin width
69	LG			1.01	mm	Gap length (Ferrite cores only)
<b>70</b>	<b>Flux and MMF calculations</b>					
71	BP_TARGET (ferrite only)	7700	Info	7700	Gauss	Info: Peak flux density is too high. Check for Inductor saturation during line transient operation
72	B_OCP (or BP)		Warning	7700	Gauss	Warning: Peak flux density is too high. Check for Inductor saturation during load steps
73	B_MAX			1303	Gauss	Peak flux density at AC peak, VACMIN and Full Power Load, nominal inductance, minimum IOCP
74	μ_TARGET (powder only)			N/A	%	target μ at peak current divided by μ at zero current, at VACMIN, full load (powder only) - drives auto core selection
75	μ_MAX (powder only)			N/A	%	actual μ at peak current divided by μ at zero current, at VACMIN, full load (powder only)
76	μ_OCP (powder only)			N/A	%	μ at IOCPtyp divided by μ at zero current
77	I_TEST	1.5		1.5	A	Current at which B_TEST and H_TEST are calculated, for checking flux at a current other than IOCP or IP; if blank IOCP_typ is used.
78	B_TEST			3850	Gauss	Flux density at I_TEST and maximum tolerance



						inductance
79	$\mu$ _TEST (powder only)			N/A	%	$\mu$ at IOCP divided by $\mu$ at zero current, at IOCPtyp
<b>80</b>	<b>Wire</b>					
81	URNS			227		Inductor turns. To adjust turns, change BP_TARGET (ferrite) or $\mu$ _TARGET (powder)
82	ILRMS			0.28	A	Inductor RMS current
83	Wire type	Magnet		Magnet		Select between "Litz" or "Magnet" for double coated magnet wire
84	AWG	32		32	AWG	Inductor wire gauge
85	Filar	2		2		Inductor wire number of parallel strands. Leave blank to auto-calc for Litz
86	OD (per strand)			0.203	mm	Outer diameter of single strand of wire
87	OD bundle (Litz only)			N/A	mm	Will be different than OD if Litz
88	DCR			2.756	ohm	Choke DC Resistance
89	P AC Resistance Ratio			1.16		Ratio of total copper loss, including HF AC, to the DC component of the loss
90	J			4.30	A/mm <sup>2</sup>	Estimated current density of wires. It is recommended that $4 < J < 6$
91	FIT			4	%	Percentage fill of winding window for EE/PQ core. Full window approx. 90%
92	Layers			3.13		Estimated layers in winding
<b>93</b>	<b>Loss calculations</b>					
94	BAC-p-p			914	Gauss	Core AC peak-peak flux excursion at VACMIN, peak of sine wave
95	LPFC_CORE_LOSS			0.025	W	Estimated Inductor core Loss
96	LPFC_COPPER_LOSS			0.249	W	Estimated Inductor copper losses
97	LPFC_TOTAL_LOSS			0.274	W	Total estimated Inductor Losses
<b>100</b>	<b>External PFC Diode</b>					
101	PFC Diode Part Number	Auto		LXA03T600		PFC Diode Part Number
102	Type			Qspeed		PFC Diode Type
103	Manufacturer			PI		Diode Manufacturer
104	VRRM			600.0	V	Diode rated reverse voltage
105	IF			3.00	A	Diode rated forward current
106	Qrr			50.0	nC	Qrr at High Temperature
107	VF			2.10	V	Diode rated forward voltage drop
108	PCOND_DIODE			0.238	W	Estimated Diode conduction losses
109	PSW_DIODE			0.157	W	Estimated Diode switching losses
110	P_DIODE			0.395	W	Total estimated Diode losses
111	TJ Max			100.0	deg C	Maximum steady-state operating temperature
112	Rth-JS			1.90	degC/W	Maximum thermal resistance (Junction to heatsink)
113	HEATSINK Theta-CA			149.65	degC/W	Maximum thermal resistance of heatsink
114	IFSM			23.0	A	Non-repetitive peak surge current rating. Consider larger size diode if inrush or thermal limited.
<b>117</b>	<b>Output Capacitor</b>					
118	COOUT	82		82	$\mu$ F	Minimum value of Output capacitance
119	VO_RIPPLE_EXPECTED			4.4	V	Expected ripple voltage on Output with selected Output capacitor
120	T_HOLDUP_EXPECTED			56.4	ms	Expected holdup time with selected Output capacitor
121	ESR_LF		Warning	6.03	ohms	!!! Warning Low frequency ESR must be between 0.01 and 3 ohms
122	ESR_HF		Warning	2.41	ohms	!!! Warning high frequency ESR must be between 0.01 and 1 ohms
123	IC_RMS_LF			0.08	A	Low Frequency Capacitor RMS current
124	IC_RMS_HF			0.14	A	High Frequency Capacitor RMS current
125	CO_LF_LOSS			0.037	W	Estimated Low Frequency ESR loss in Output capacitor
126	CO_HF_LOSS			0.050	W	Estimated High frequency ESR loss in Output capacitor

127	Total CO LOSS			0.087	W	Total estimated losses in Output Capacitor
<b>130</b>	<b>Input Bridge (BR1) and Fuse (F1)</b>					
131	I <sup>2</sup> t Rating			5.72	A <sup>2</sup> *s	Minimum I <sup>2</sup> t rating for fuse
132	Fuse Current rating			0.77	A	Minimum Current rating of fuse
133	VF			0.90	V	Input bridge Diode forward Diode drop
134	I <sub>AVG</sub>			0.48	A	Input average current at VBROWNOUT.
135	PIV_INPUT BRIDGE			373	V	Peak inverse voltage of input bridge
136	PCOND_LOSS_BRIDGE			0.417	W	Estimated Bridge Diode conduction loss
137	CIN			0.10	uF	Input capacitor. Use metallized polypropylene or film foil type with high ripple current rating
138	CIN_DF			0.001		Input Capacitor Dissipation Factor (tan Delta)
139	CIN_PLOSS			0.002	W	Input Capacitor Loss
140	RT1			9.33	ohms	Input Thermistor value
141	D_Precharge			1N5407		Recommended precharge Diode
<b>144</b>	<b>PFS4 small signal components</b>					
145	C_REF			0.1	uF	REF pin capacitor value
146	RV1			4.0	MOhms	Line sense resistor 1
147	RV2			6.0	MOhms	Line sense resistor 2
148	RV3			6.0	MOhms	Typical value of the lower resistor connected to the V-PIN. Use 1% resistor only!
149	RV4			151.7	kOhms	Description pending, could be modified based on feedback chain R1-R4
150	C_V			0.527	nF	V pin decoupling capacitor (RV4 and C_V should have a time constant of 80us) Pick the closest available capacitance.
151	C_VCC			1.0	uF	Supply decoupling capacitor
152	C_C			100	nF	Feedback C pin decoupling capacitor
153	Power good Vo lower threshold VPG(L)			333	V	Vo lower threshold voltage at which power good signal will trigger
154	PGT set resistor			312.7	kohm	Power good threshold setting resistor
<b>157</b>	<b>Feedback Components</b>					
158	RFB_1			4.00	Mohms	Feedback network, first high voltage divider resistor
159	RFB_2			6.00	Mohms	Feedback network, second high voltage divider resistor
160	RFB_3			6.00	Mohms	Feedback network, third high voltage divider resistor
161	RFB_4			151.7	kohms	Feedback network, lower divider resistor
162	CFB_1			0.527	nF	Feedback network, loop speedup capacitor. (R4 and C1 should have a time constant of 80us) Pick the closest available capacitance.
163	RFB_5			80.6	kohms	Feedback network: zero setting resistor
164	CFB_2			1000	nF	Feedback component- noise suppression capacitor
<b>167</b>	<b>Loss Budget (Estimated at VACMIN)</b>					
168	PFS Losses			1.047	W	Total estimated losses in PFS
169	Boost diode Losses			0.395	W	Total estimated losses in Output Diode
170	Input Bridge losses			0.417	W	Total estimated losses in input bridge module
171	Input Capacitor Losses			0.002	W	Total estimated losses in input capacitor
172	Inductor losses			0.274	W	Total estimated losses in PFC choke
173	Output Capacitor Loss			0.087	W	Total estimated losses in Output capacitor
174	EMI choke copper loss			0.007	W	Total estimated losses in EMI choke copper
175	Total losses			2.229	W	Overall loss estimate
176	Efficiency			0.95		Estimated efficiency at VACMIN, full load.
<b>179</b>	<b>CAPZero component selection recommendation</b>					
180	CAPZero Device			CAP200DG		(Optional) Recommended CAPZero device to discharge X-Capacitor with time constant of 1 second
181	Total Series Resistance (Rcapzero1+Rcapzero2)			1.046	MOhms	Maximum Total Series resistor value to discharge X-Capacitors
<b>184</b>	<b>EMI filter components recommendation</b>					
185	CX2			330	nF	X capacitor after differential mode choke and



						before bridge, ratio with Po
186	LDM_calc			590	uH	Estimated minimum differential inductance to avoid <10kHz resonance in input current
187	CX1			330	nF	X capacitor before common mode choke, ratio with Po
188	LCM			10.0	mH	typical common mode choke value
189	LCM_leakage			30	uH	estimated leakage inductance of CM choke, typical from 30~60uH
190	CY1 (and CY2)			220	pF	typical Y capacitance for common mode noise suppression
191	LDM_Actual			560	uH	cal_LDM minus LCM_leakage, utilizing CM leakage inductance as DM choke.
192	DCR_LCM			0.070	Ohms	Total DCR of CM choke for estimating copper loss
193	DCR_LDM			0.030	Ohms	Total DCR of DM choke(or CM #2) for estimating copper loss
195	Note: CX2 can be placed between CM chock and DM choke depending on EMI design requirement.					

**Note:** All warnings/info flags were verified during optimization and actual bench test using prototype design unit.

## 10 Flyback DC-DC Transformer Spreadsheet

1	DCDC_LYTSwitch 6_Flyback_04041 9; Rev.1.0; Copyright Power Integrations 2019	INPUT	INFO	OUTPUT	UNITS	DCDC LYTSwitch6 Flyback Design Spreadsheet
<b>2</b>	<b>APPLICATION VARIABLES</b>					
3	VDCIN_MIN	405		405	V	Minimum input DC voltage
4	VDCIN_MAX	415		415	V	Maximum input DC voltage
5	VOUT	42.00		42.00	V	Output voltage
6	IOUT	1.000		1.000	A	Output current
7	POUT			42.00	W	Output power
8	EFFICIENCY	0.95		0.95		DC-DC efficiency estimate at full load
9	FACTOR_Z			0.50		Z-factor estimate
10	ENCLOSURE	ADAPTER		ADAPTER		Power supply enclosure
<b>12</b>	<b>PRIMARY CONTROLLER SELECTION</b>					
13	ILIMIT_MODE	STANDARD		STANDARD		Device current limit mode
14	VDRAIN_BREAKDOWN	650		650	V	Device breakdown voltage
15	DEVICE_GENERIC	AUTO		LYT60X7		Generic device code
16	DEVICE_CODE			LYT6067C		Actual device code
17	POUT_MAX			60	W	Power capability of the device based on thermal performance
18	RDSON_100DEG			1.82	$\Omega$	Primary switch on time drain resistance at 100 degC
19	ILIMIT_MIN			1.348	A	Minimum current limit of the primary switch
20	ILIMIT_TYP			1.450	A	Typical current limit of the primary switch
21	ILIMIT_MAX			1.552	A	Maximum current limit of the primary switch
22	VDRAIN_ON_PRSW			0.19	V	Primary switch on time drain voltage
23	VDRAIN_OFF_PRSW			565.0	V	Peak drain voltage on the primary switch during turn-off
<b>25</b>	<b>WORST CASE ELECTRICAL PARAMETERS</b>					
26	FSWITCHING_MAX	85000		85000	Hz	Maximum switching frequency at full load and minimum DC input voltage
27	VOR	80.0		80.0	V	Secondary voltage reflected to the primary when the primary switch turns off
28	KP			1.02		Measure of continuous/discontinuous mode of operation
29	MODE_OPERATION			DCM		Mode of operation
30	DUTYCYCLE			0.162		Primary switch duty cycle
31	TIME_ON			2.31	us	Primary switch on-time
32	TIME_OFF			9.87	us	Primary switch off-time
33	LPRIMARY_MIN			577.1	uH	Minimum primary inductance
34	LPRIMARY_TYP	608		607.5	uH	Typical primary inductance
35	LPRIMARY_TOL			5.0	%	Primary inductance tolerance
36	LPRIMARY_MAX			637.9	uH	Maximum primary inductance
<b>38</b>	<b>PRIMARY CURRENTS</b>					
39	IPEAK_PRIMARY			1.483	A	Primary switch peak current
40	IPEDESTAL_PRIMARY			0.000	A	Primary switch current pedestal
41	Iavg_PRIMARY			0.106	A	Primary switch average current
42	IRIPPLE_PRIMARY			1.483	A	Primary switch ripple current
43	IRMS_PRIMARY			0.324	A	Primary switch RMS current
<b>45</b>	<b>SECONDARY CURRENTS</b>					
46	IPEAK_SECONDARY			2.842	A	Secondary winding peak current
47	IPEDESTAL_SECONDARY			0.000	A	Secondary winding current pedestal





48	IRMS_SECONDARY			1.399	A	Secondary winding RMS current
49	IRIPPLE_CAP_OUT					
<b>51</b>	<b>TRANSFORMER CONSTRUCTION PARAMETERS</b>					
<b>52</b>	<b>CORE SELECTION</b>					
53	CORE	PQ20/20		PQ20/20		Core selection
54	CORE CODE			B65875A0000R095		Core code
55	AE			62.90	mm <sup>2</sup>	Core cross sectional area
56	LE			45.20	mm	Core magnetic path length
57	AL			3300	nH/turns <sup>2</sup>	Ungapped core effective inductance
58	VE			2843.0	mm <sup>3</sup>	Core volume
59	BOBBIN			B65876E1014D001		Bobbin
60	AW			35.00	mm <sup>2</sup>	Window area of the bobbin
61	BW			11.70	mm	Bobbin width
62	MARGIN			0.0	mm	Safety margin width (Half the primary to secondary creepage distance)
<b>64</b>	<b>PRIMARY WINDING</b>					
65	NPRIMARY			46		Primary turns
66	BPEAK			3502	Gauss	Peak flux density
67	BMAX			3230	Gauss	Maximum flux density
68	BAC			1615	Gauss	AC flux density (0.5 x Peak to Peak)
69	ALG			287	nH/turns <sup>2</sup>	Typical gapped core effective inductance
70	LG			0.251	mm	Core gap length
71	LAYERS_PRIMARY			1		Number of primary layers
72	AWG_PRIMARY	32		32	AWG	Overwriting the primary AWG may not guarantee the required number of layers as calculated by the spreadsheet
73	OD_PRIMARY_INSULATED			0.244	mm	Primary winding wire outer diameter with insulation
74	OD_PRIMARY_BARE			0.202	mm	Primary winding wire outer diameter without insulation
75	CMA_PRIMARY		Warning	195	Cmil/A	Primary winding wire CMA
<b>77</b>	<b>PRIMARY BIAS WINDING</b>					
78	NBIAS_PRIMARY			11		Primary bias turns
80	SECONDARY WINDING					
81	NSECONDARY	24		24		Secondary turns
82	AWG_SECONDARY			25	AWG	Secondary winding wire AWG
83	OD_SECONDARY_INSULATED			0.760	mm	Secondary winding wire outer diameter with insulation
84	OD_SECONDARY_BARE			0.455	mm	Secondary winding wire outer diameter without insulation
85	CMA_SECONDARY			229	Cmil/A	Secondary winding wire CMA
<b>87</b>	<b>SECONDARY BIAS WINDING</b>					
88	NBIAS_SECONDARY			10		Secondary bias turns (Required only for VOUT>24V or VOUT<4.4V)
<b>90</b>	<b>PRIMARY COMPONENTS SELECTION</b>					
<b>91</b>	<b>LINE UNDERVOLTAGE</b>					
92	OV_REQUIRED			423.3	V	Required DC over-voltage threshold
93	OV_ACTUAL			430.2	V	Actual DC over-voltage threshold
94	RLS			3.64	MΩ	Connect two 1.82 MOhm resistors to the V-pin for the required UV/OV threshold
95	BROWN-IN_ACTUAL			103.2	V	Actual DC brown-in threshold
96	BROWN-OUT_ACTUAL			93.4	V	Actual DC brown-out threshold
<b>99</b>	<b>PRIMARY BIAS WINDING DIODE</b>					
100	VBIAS_PRIMARY	18.0		18.0	V	Rectified bias voltage
101	VF_BIAS_PRIMARY			0.70	V	Secondary bias winding diode forward drop
102	VREVERSE_PRI_BIAS DIODE_PRIMARY			117.24	V	Primary bias diode reverse voltage (not accounting parasitic voltage ring)

103	CBIAS_PRIMARY			22	uF	Primary bias winding rectification capacitor
104	CBPP			0.47	uF	BPP pin capacitor
<b>106</b>	<b>SECONDARY COMPONENTS</b>					
<b>107</b>	<b>FEEDBACK</b>					
108	RFB_UPPER	100.00		100.00	kΩ	Upper feedback resistor (connected to the first output voltage)
109	RFB_LOWER			3.09	kΩ	Lower feedback resistor
110	CFB_LOWER			330	pF	Lower feedback resistor decoupling capacitor
<b>112</b>	<b>RECTIFIER</b>					
113	VREVERSE_RECTIFIER			258.5		Secondary rectifier reverse voltage (not accounting parasitic voltage ring)
114	TYPE_RECTIFIER	AUTO		DIODE		Type of secondary rectifier used
115	RECTIFIER	STTH3R04		STTH3R04		Secondary rectifier
116	VF_RECTIFIER			1.500		Secondary rectifier forward voltage drop
117	BVDSS_RECTIFIER			400		Breakdown voltage of the secondary rectifier
118	RDSON_RECTIFIER			NA		On-time drain to source resistance of the secondary rectifier
119	TRR_RECTIFIER			18.0		Reverse recovery time of the ultra-fast diode
<b>121</b>	<b>SECONDARY BIAS WINDING DIODE</b>					
122	VBIAS_SECONDARY	16		16	V	Rectified secondary bias voltage
123	VF_BIAS_SECONDARY			0.7	V	Secondary bias winding diode forward drop
124	VREVERSE_BIASDIODE_SECONDARY			106.22	V	Secondary bias diode reverse voltage (not accounting parasitic voltage ring)
125	CBIAS_SECONDARY			22	uF	Secondary bias winding rectification capacitor
<b>127</b>	<b>TOLERANCE ANALYSIS</b>					
128	USER_VDC			410	V	Input DC voltage corner to be evaluated
129	USER_ILIMIT	TYP		1.450	A	Current limit corner to be evaluated
130	USER_LPRIMARY	TYP		607.5	uH	Primary inductance corner to be evaluated
131	MODE_OPERATION			DCM		Mode of operation
132	KP			1.102		Measure of continuous/discontinuous mode of operation
133	FSWITCHING			72600	Hz	Switching frequency at full load and valley of the rectified minimum AC input voltage
134	DUTYCYCLE			0.150		Steady state duty cycle
135	TIME_ON			2.07	us	Primary switch on-time
136	TIME_OFF			11.70	us	Primary switch off-time
137	IPEAK_PRIMARY			1.398	A	Primary switch peak current
138	IPEDESTAL_PRIMARY			0.000	A	Primary switch current pedestal
139	IAVERAGE_PRIMARY			0.105	A	Primary switch average current
140	IRIPPLE_PRIMARY			1.398	A	Primary switch ripple current
141	IRMS_PRIMARY			0.313	A	Primary switch RMS current
142	BPEAK			3116	Gauss	Peak flux density
143	BMAX			2935	Gauss	Maximum flux density
144	BAC			1468	Gauss	AC flux density (0.5 x Peak to Peak)

**Note:** All warnings/info flags were verified during optimization and actual bench test using prototype design unit.



## 11 Performance Data

All measurements were performed at room temperature.

### 11.1 CV/CC Output Characteristic Curve

CC regulation was measured using E-Load at CR Load.

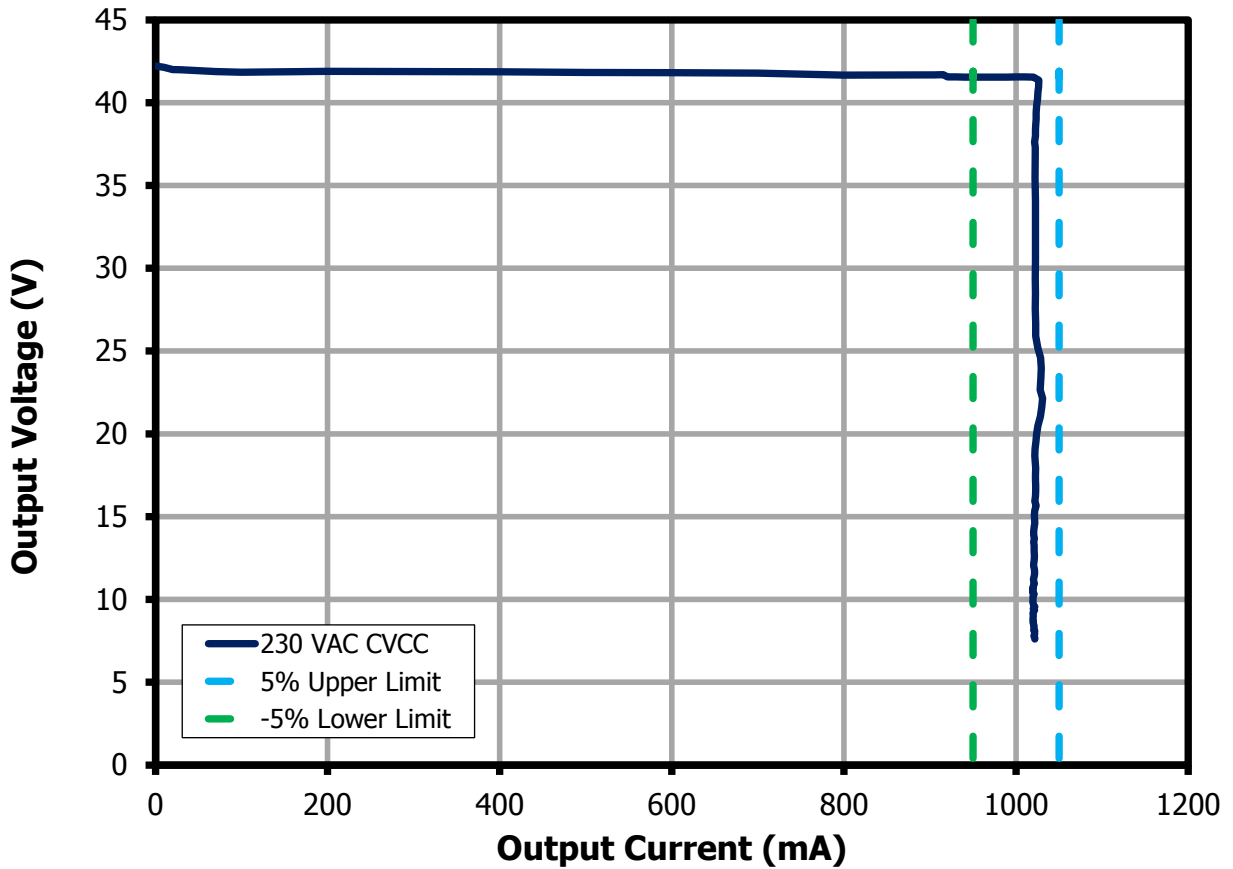


Figure 19 – CV/CC Curve.



### 11.2 System Efficiency

Efficiency is above 87% throughout the input voltage range.

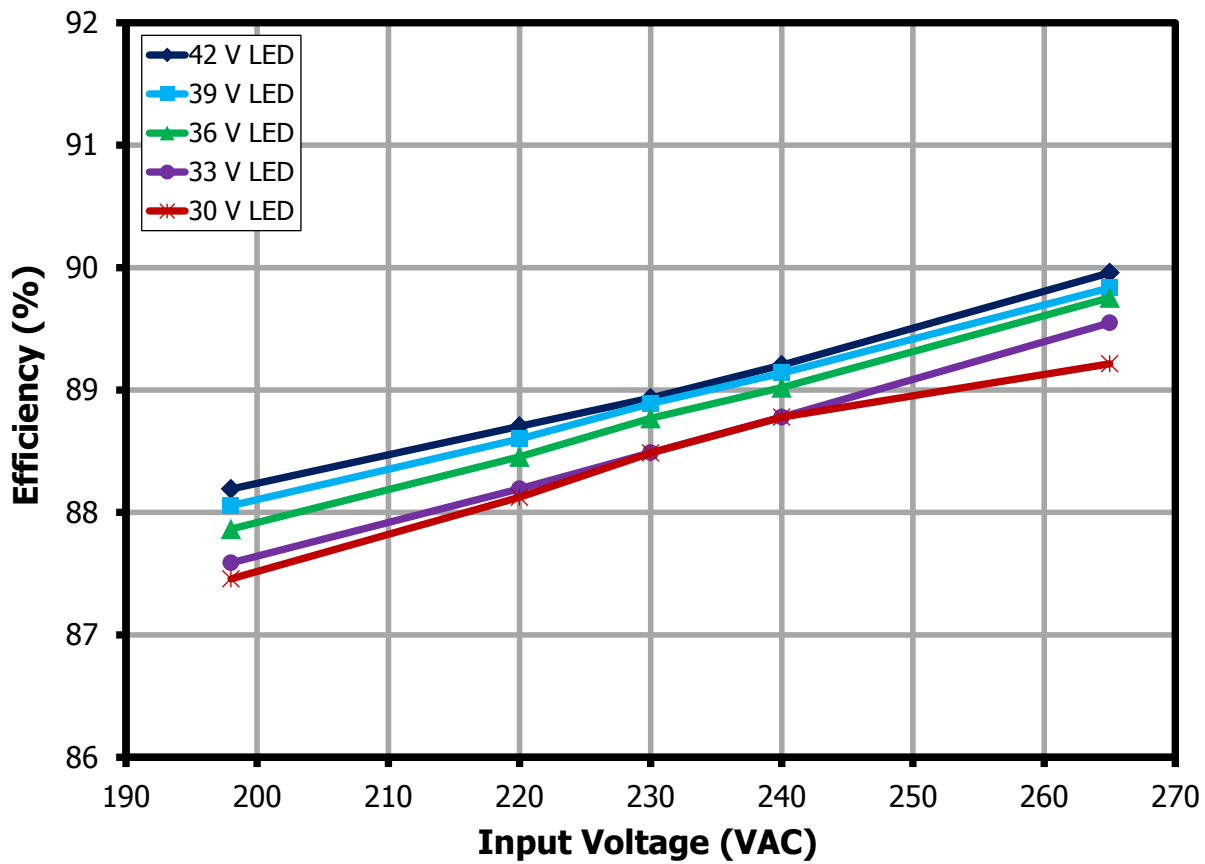


Figure 20 – Efficiency vs. Line and LED Load.

### 11.3 Output Current Regulation

Output current regulation is within 2% range.

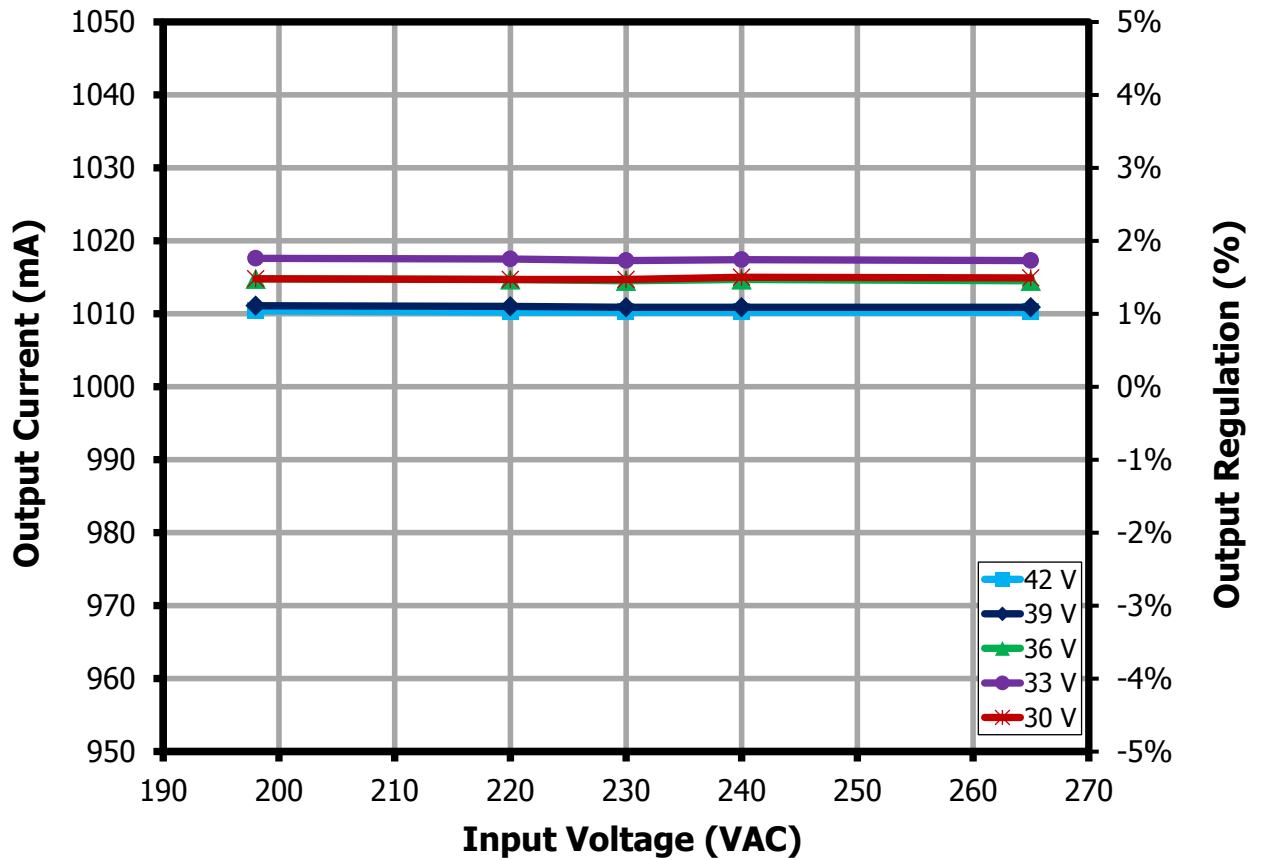


Figure 21 – Current Regulation vs. Line and LED Load.



### 11.4 Power Factor

Power Factor is greater than 0.9 throughout all the input voltage range.

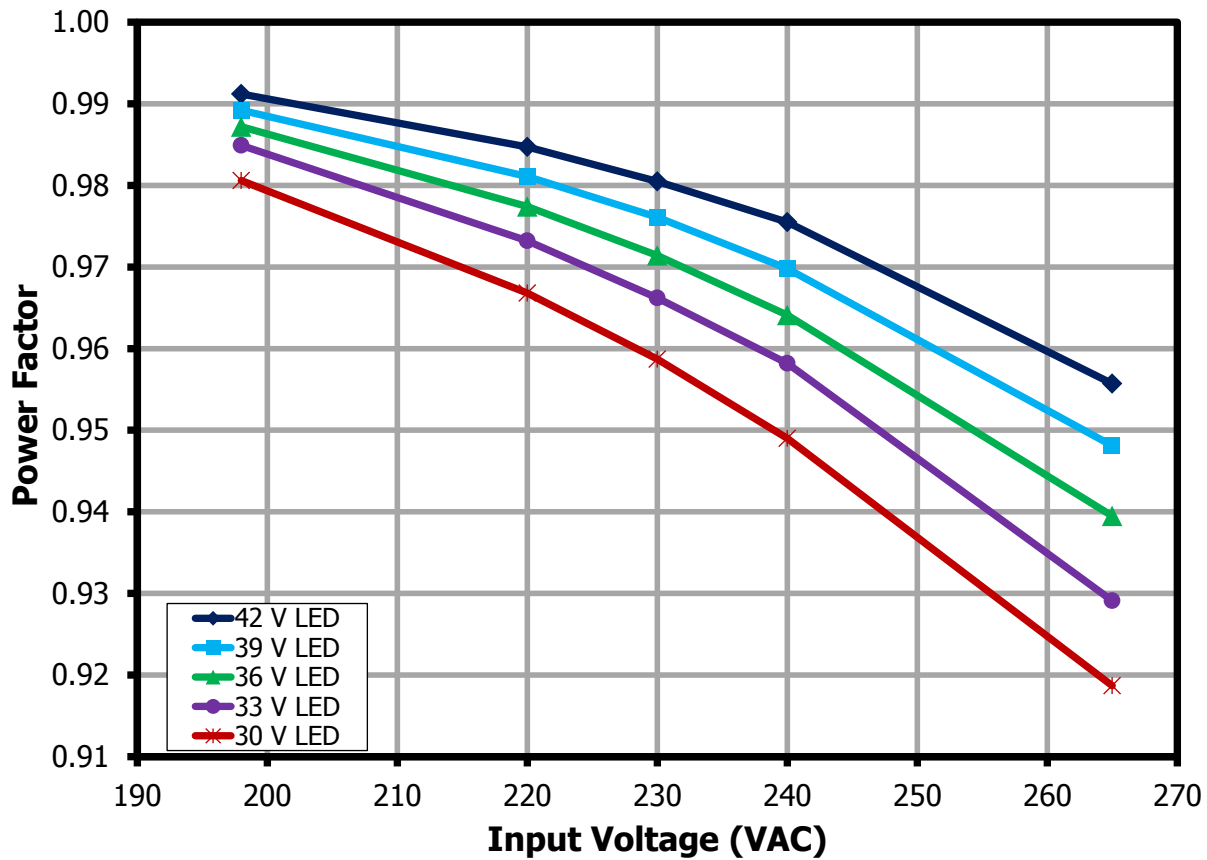


Figure 22 – Power Factor vs. Line and LED Load.

### 11.5 %ATHD

%ATHD is less than 10% throughout all the input voltage range.

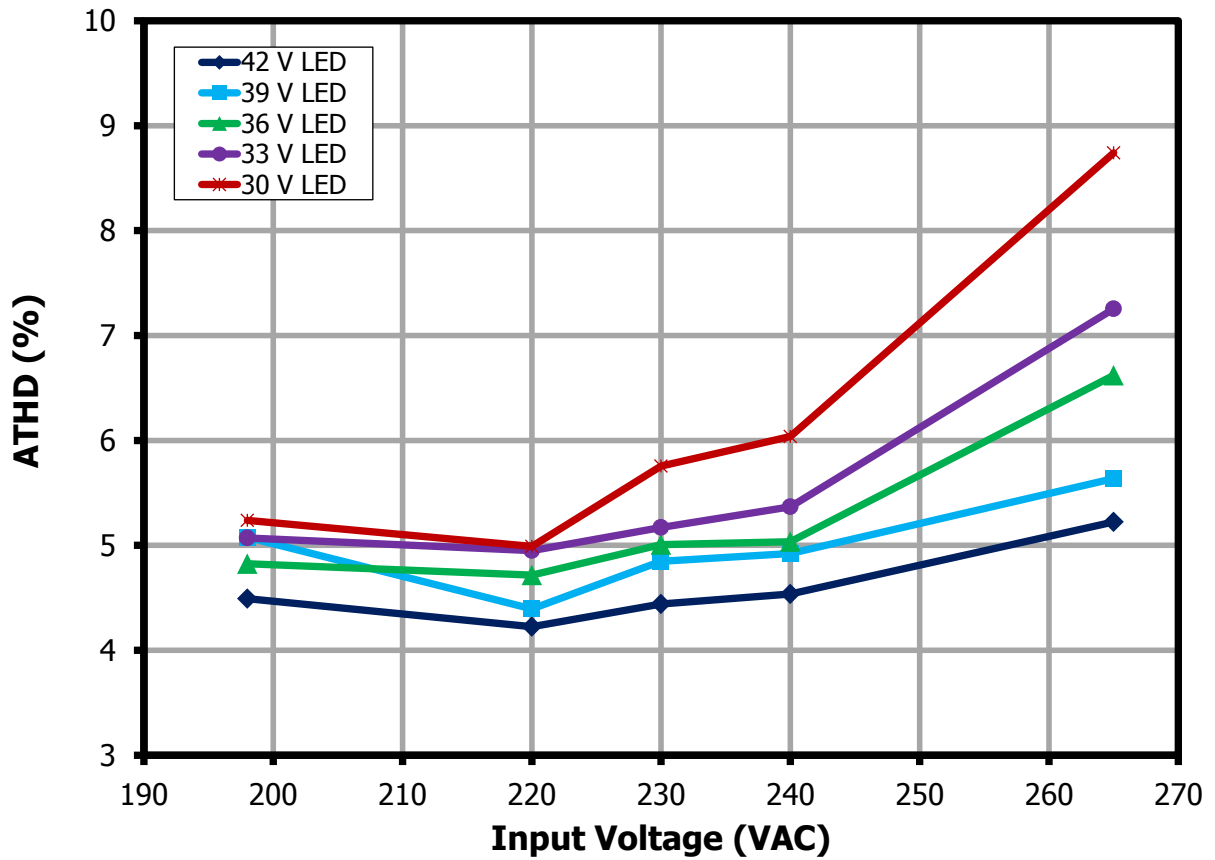


Figure 23 – %ATHD vs. Line and LED Load.



11.6 **Individual Harmonic Content at 42 V LED Load**

Current harmonic content is well below the Class C limit.

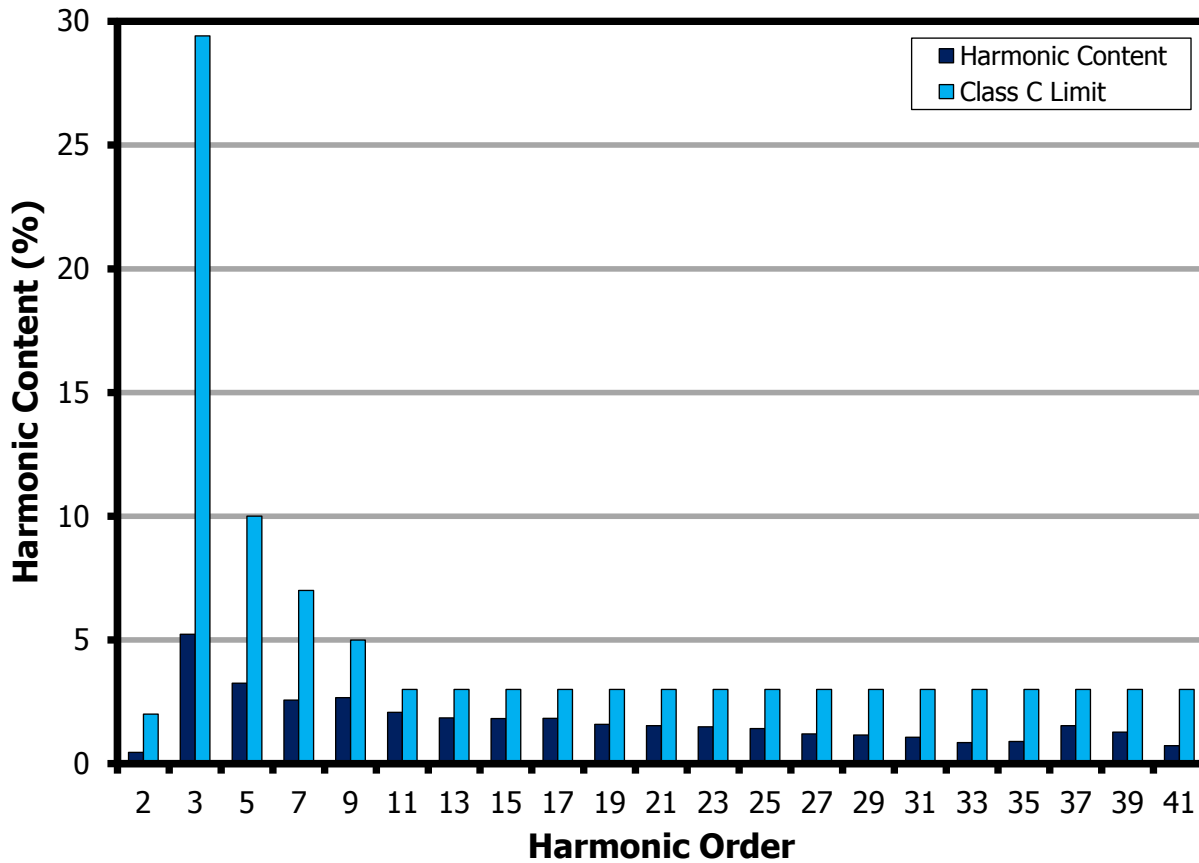


Figure 24 – 42 V LED Load Input Current Harmonics at 230 VAC, 50 Hz.



11.7 **Individual Harmonic Content at 30 V LED Load**

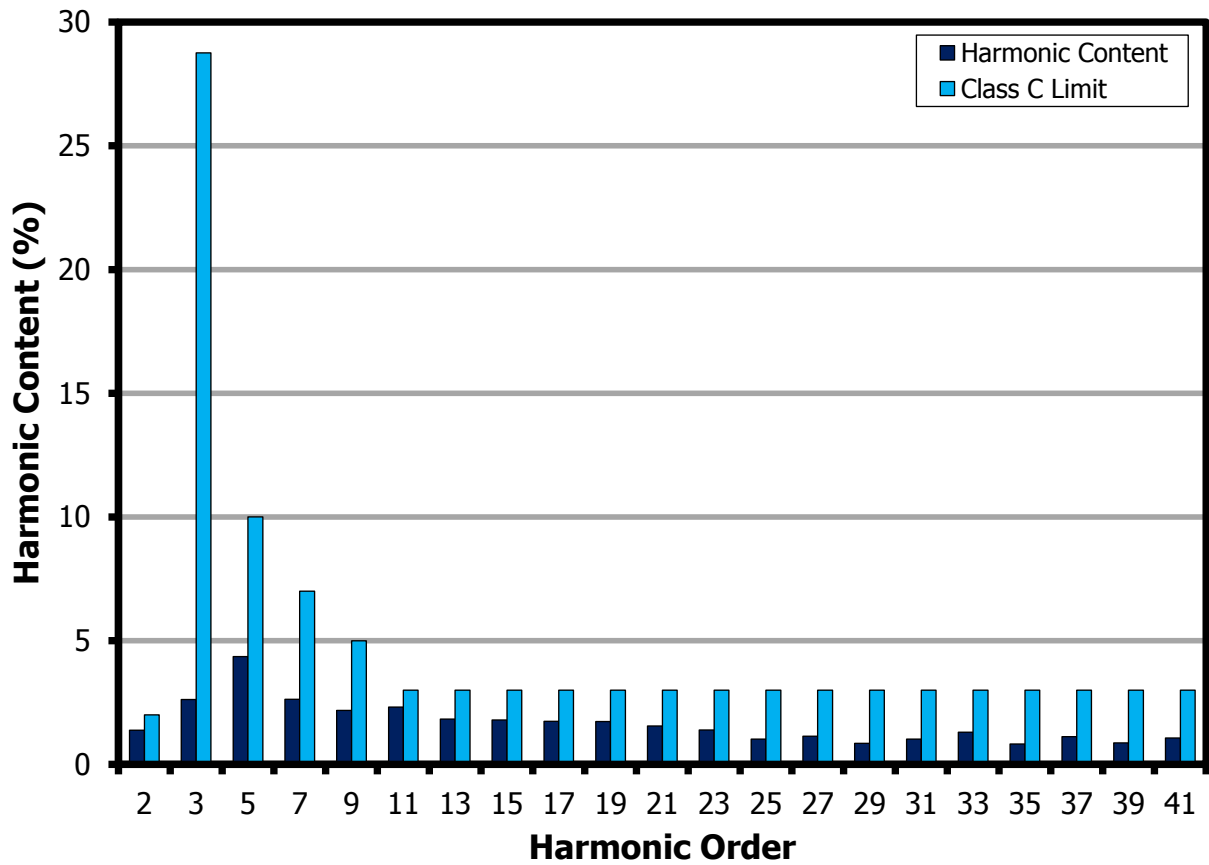


Figure 25 – 30 V LED Load Input Current Harmonics at 230 VAC, 50 Hz.

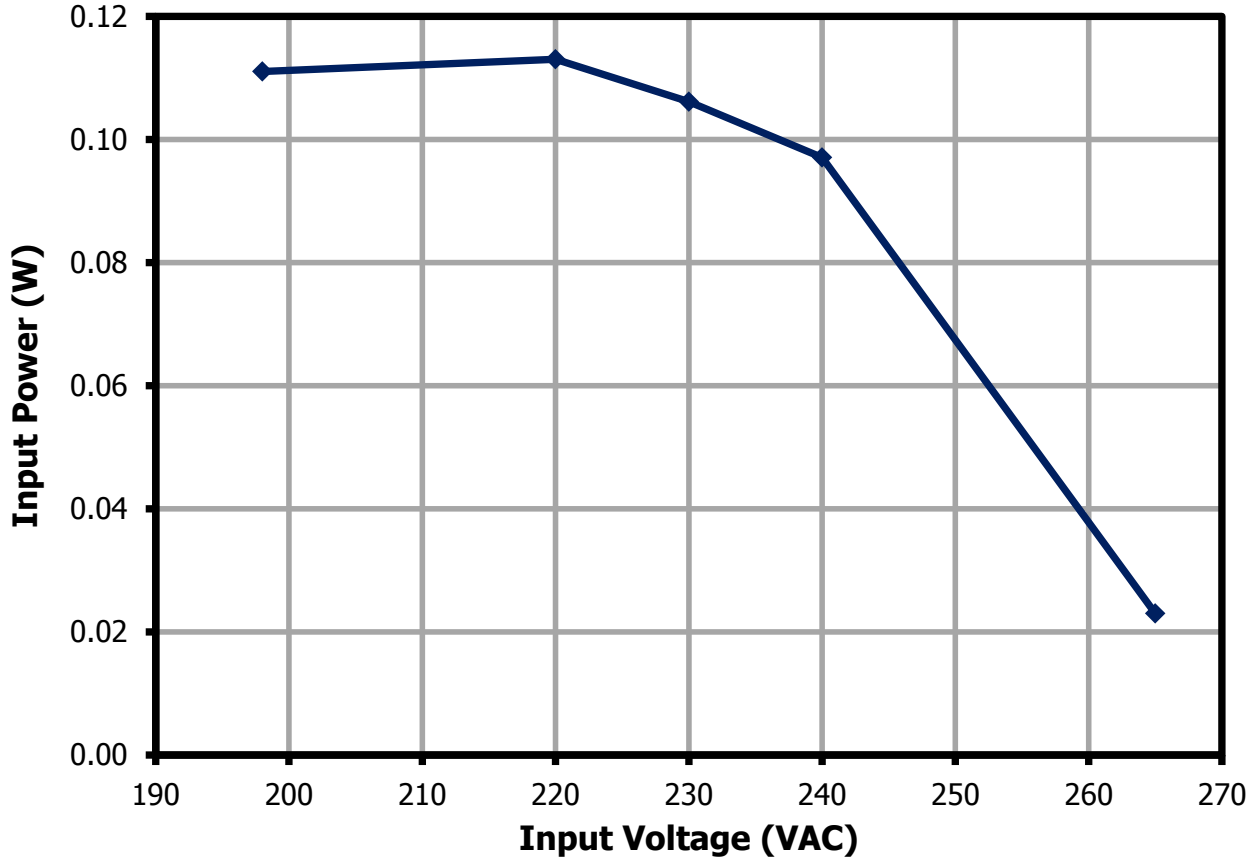


### 11.8 **No-Load Input Power of Power Board**

Integration time: 5 minutes

Dimming circuit is disconnected.

No-Load input power is less than 120 mW.



**Figure 26** – No-Load Input Power vs. Line.

## 12 Test Data

### 12.1 42 V LED Load

Input		Input Measurement					LED Load Measurement			Efficiency (%)
VAC (V <sub>RMS</sub> )	Freq (Hz)	V <sub>IN</sub> (V <sub>RMS</sub> )	I <sub>IN</sub> (mA <sub>RMS</sub> )	P <sub>IN</sub> (W)	PF	% ATHD	V <sub>OUT</sub> (V <sub>DC</sub> )	I <sub>OUT</sub> (mA <sub>DC</sub> )	P <sub>OUT</sub> (W)	
198	50	198	241.95	47.48	0.99	4.49	41.44	1010.40	41.87	88.19
220	50	220	217.85	47.19	0.98	4.23	41.44	1010.20	41.86	88.70
230	50	230	208.71	47.07	0.98	4.44	41.44	1010.20	41.86	88.93
240	50	240	200.51	46.93	0.98	4.54	41.44	1010.20	41.87	89.20
265	50	265	183.76	46.54	0.96	5.22	41.44	1010.20	41.86	89.96

### 12.2 39 V LED Load

Input		Input Measurement					LED Load Measurement			Efficiency (%)
VAC (V <sub>RMS</sub> )	Freq (Hz)	V <sub>IN</sub> (V <sub>RMS</sub> )	I <sub>IN</sub> (mA <sub>RMS</sub> )	P <sub>IN</sub> (W)	PF	% ATHD	V <sub>OUT</sub> (V <sub>DC</sub> )	I <sub>OUT</sub> (mA <sub>DC</sub> )	P <sub>OUT</sub> (W)	
198	50	198	226.68	44.39	0.99	5.08	38.65	1011.10	39.08	88.05
220	50	220	204.29	44.10	0.98	4.40	38.65	1011.00	39.08	88.60
230	50	230	195.86	43.96	0.98	4.85	38.66	1010.90	39.08	88.89
240	50	240	188.35	43.83	0.97	4.92	38.65	1010.90	39.07	89.14
265	50	265	173.07	43.49	0.95	5.64	38.65	1010.90	39.07	89.83

### 12.3 36 V LED Load

Input		Input Measurement					LED Load Measurement			Efficiency (%)
VAC (V <sub>RMS</sub> )	Freq (Hz)	V <sub>IN</sub> (V <sub>RMS</sub> )	I <sub>IN</sub> (mA <sub>RMS</sub> )	P <sub>IN</sub> (W)	PF	% ATHD	V <sub>OUT</sub> (V <sub>DC</sub> )	I <sub>OUT</sub> (mA <sub>DC</sub> )	P <sub>OUT</sub> (W)	
198	50	198	211.78	41.40	0.99	4.83	35.84	1014.80	36.37	87.86
220	50	220	191.20	41.12	0.98	4.72	35.84	1014.70	36.37	88.45
230	50	230	183.32	40.96	0.97	5.01	35.84	1014.50	36.36	88.77
240	50	240	176.58	40.86	0.96	5.04	35.84	1014.70	36.37	89.02
265	50	265	162.70	40.51	0.94	6.62	35.84	1014.50	36.36	89.75

### 12.4 33 V LED Load

Input		Input Measurement					LED Load Measurement			Efficiency (%)
VAC (V <sub>RMS</sub> )	Freq (Hz)	V <sub>IN</sub> (V <sub>RMS</sub> )	I <sub>IN</sub> (mA <sub>RMS</sub> )	P <sub>IN</sub> (W)	PF	% ATHD	V <sub>OUT</sub> (V <sub>DC</sub> )	I <sub>OUT</sub> (mA <sub>DC</sub> )	P <sub>OUT</sub> (W)	
198	50	198	197.20	38.45	0.98	5.07	33.10	1017.60	33.68	87.59
220	50	220	178.35	38.19	0.97	4.95	33.10	1017.50	33.68	88.19
230	50	230	171.23	38.05	0.97	5.17	33.10	1017.30	33.67	88.49
240	50	240	164.96	37.93	0.96	5.37	33.10	1017.40	33.67	88.78
265	50	265	152.71	37.60	0.93	7.26	33.09	1017.30	33.67	89.55

12.5 **30 V LED Load**

Input		Input Measurement					LED Load Measurement			Efficiency (%)
VAC (V <sub>RMS</sub> )	Freq (Hz)	V <sub>IN</sub> (V <sub>RMS</sub> )	I <sub>IN</sub> (mA <sub>RMS</sub> )	P <sub>IN</sub> (W)	PF	% ATHD	V <sub>OUT</sub> (V <sub>DC</sub> )	I <sub>OUT</sub> (mA <sub>DC</sub> )	P <sub>OUT</sub> (W)	
198	50	198	185.96	36.11	0.98	5.24	31.12	1014.80	31.58	87.46
220	50	220	168.46	35.83	0.97	4.99	31.12	1014.70	31.58	88.12
230	50	230	161.80	35.68	0.96	5.76	31.12	1014.70	31.58	88.49
240	50	240	156.21	35.58	0.95	6.04	31.12	1015.00	31.58	88.78
265	50	265	145.40	35.40	0.92	8.74	31.12	1014.90	31.58	89.21

12.6 **No-Load**

Input		Input Measurement			V <sub>OUT</sub>
VAC (V <sub>RMS</sub> )	Freq (Hz)	V <sub>IN</sub> (V <sub>RMS</sub> )	I <sub>IN</sub> (mA <sub>RMS</sub> )	P <sub>IN</sub> (W)	V (V <sub>DC</sub> )
198	50	198	22.30	0.111	42.21
220	50	220	23.59	0.113	42.21
230	50	230	24.16	0.106	42.21
240	50	240	27.07	0.097	42.21
265	50	265	26.34	0.023	42.20

12.7 **Individual Harmonic Content at 42 V LED Load**

$V_{IN}$ ( $V_{RMS}$ )	Freq	$I_{IN}$ ( $mA_{RMS}$ )	$P_{IN}$ (W)	PF	%THD
230	50	211.05	46.94	0.967	7.454
<b>Harmonic Content</b>			<b>Class C Limit</b>		
nth Order	mA Content	% Content	mA Limit <25 W	mA Limit >25 W	Remarks
<b>1</b>	209.89				
<b>2</b>	0.09	0.043		2	pass
<b>3</b>	12.35	5.884	159.596	29.01	pass
<b>5</b>	5.99	2.854	89.186	10	pass
<b>7</b>	3.13	1.491	46.94	7	pass
<b>9</b>	2.35	1.12	23.47	5	pass
<b>11</b>	2.21	1.053	16.429	3	pass
<b>13</b>	2.32	1.105	13.901	3	pass
<b>15</b>	2.08	0.991	12.048	3	pass
<b>17</b>	1.86	0.886	10.631	3	pass
<b>19</b>	1.81	0.862	9.512	3	pass
<b>21</b>	1.59	0.758	8.606	3	pass
<b>23</b>	1.7	0.81	7.857	3	pass
<b>25</b>	1.37	0.653	7.229	3	pass
<b>27</b>	1.18	0.562	6.693	3	pass
<b>29</b>	1.05	0.5	6.232	3	pass
<b>31</b>	1.08	0.515	5.83	3	pass
<b>33</b>	0.92	0.438	5.476	3	pass
<b>35</b>	0.62	0.295	5.163	3	pass
<b>37</b>	0.42	0.2	4.884	3	pass
<b>39</b>	1	0.476	4.634	3	pass
<b>41</b>	0.34	0.162	4.408	3	pass

12.8 **Individual Harmonic Content at 30 V LED Load**

$V_{IN}$ ( $V_{RMS}$ )	Freq	$I_{IN}$ ( $mA_{RMS}$ )	$P_{IN}$ (W)	PF	%THD
230	50	161.89	35.70	0.96	5.37
<b>Harmonic Content</b>			<b>Class C Limit</b>		
<b>nth Order</b>	<b>mA Content</b>	<b>% Content</b>	<b>mA Limit &lt;25 W</b>	<b>mA Limit &gt;25 W</b>	<b>Remarks</b>
<b>1</b>	158.72				
<b>2</b>	1.38	0.87		2	pass
<b>3</b>	2.62	1.65	121.38	28.76	pass
<b>5</b>	4.36	2.75	67.83	10	pass
<b>7</b>	2.63	1.66	35.70	7	pass
<b>9</b>	2.18	1.37	17.85	5	pass
<b>11</b>	2.32	1.46	12.50	3	pass
<b>13</b>	1.83	1.15	10.57	3	pass
<b>15</b>	1.80	1.13	9.16	3	pass
<b>17</b>	1.74	1.10	8.09	3	pass
<b>19</b>	1.73	1.09	7.23	3	pass
<b>21</b>	1.55	0.98	6.55	3	pass
<b>23</b>	1.39	0.88	5.98	3	pass
<b>25</b>	1.02	0.64	5.50	3	pass
<b>27</b>	1.14	0.72	5.09	3	pass
<b>29</b>	0.85	0.54	4.74	3	pass
<b>31</b>	1.02	0.64	4.43	3	pass
<b>33</b>	1.30	0.82	4.17	3	pass
<b>35</b>	0.83	0.52	3.93	3	pass
<b>37</b>	1.12	0.71	3.71	3	pass
<b>39</b>	0.87	0.55	3.52	3	pass
<b>41</b>	1.07	0.67	3.35	3	pass

### 13 Dimming Performance

Dimming performance data were taken at room temperature. The dimming input is an isolated 5 V peak PWM variable duty cycle at 300 Hz and 1 kHz.

#### 13.1 Dimming Curve

##### 13.1.1 1% to 10% Duty Cycle

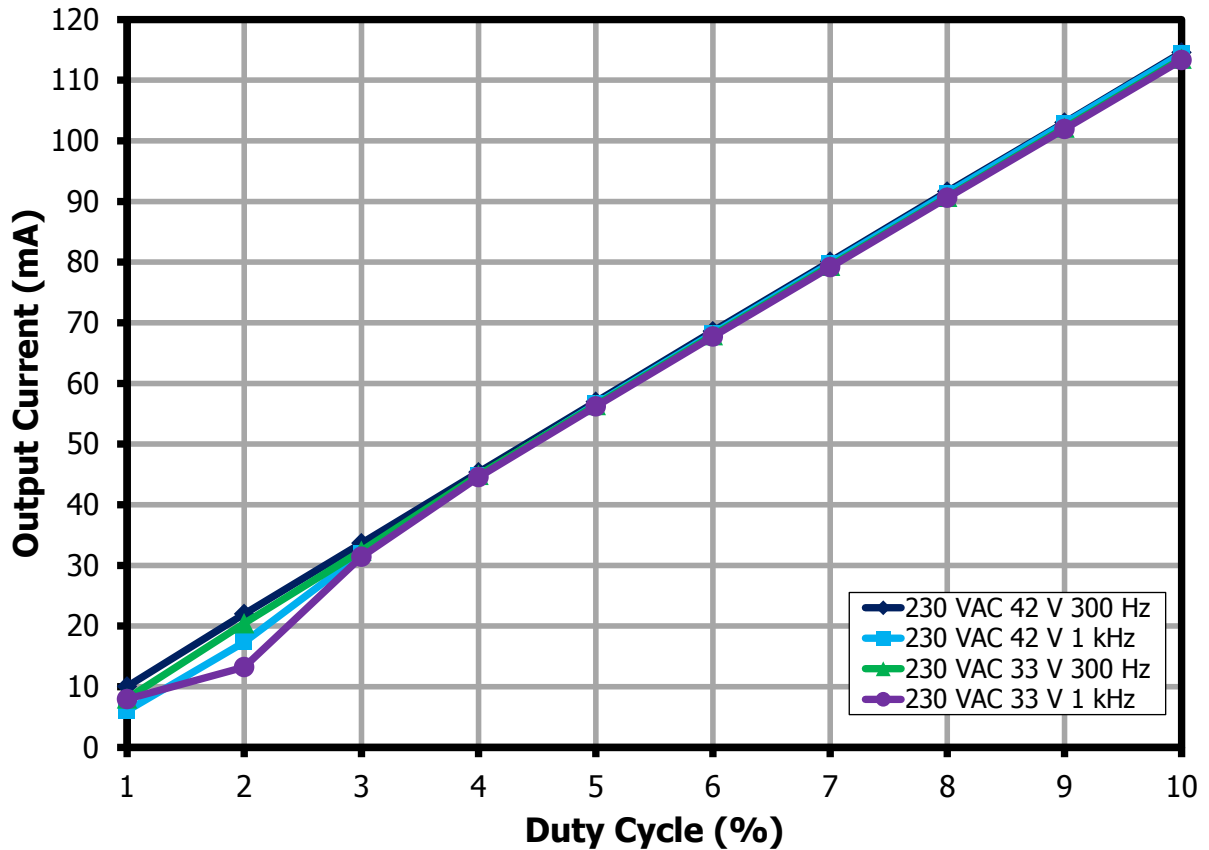


Figure 27 – 5 V PWM Dimming Curve at 42 V and 33 V LED Load 1% to 10%.



13.1.2 10% to 100% Duty Cycle

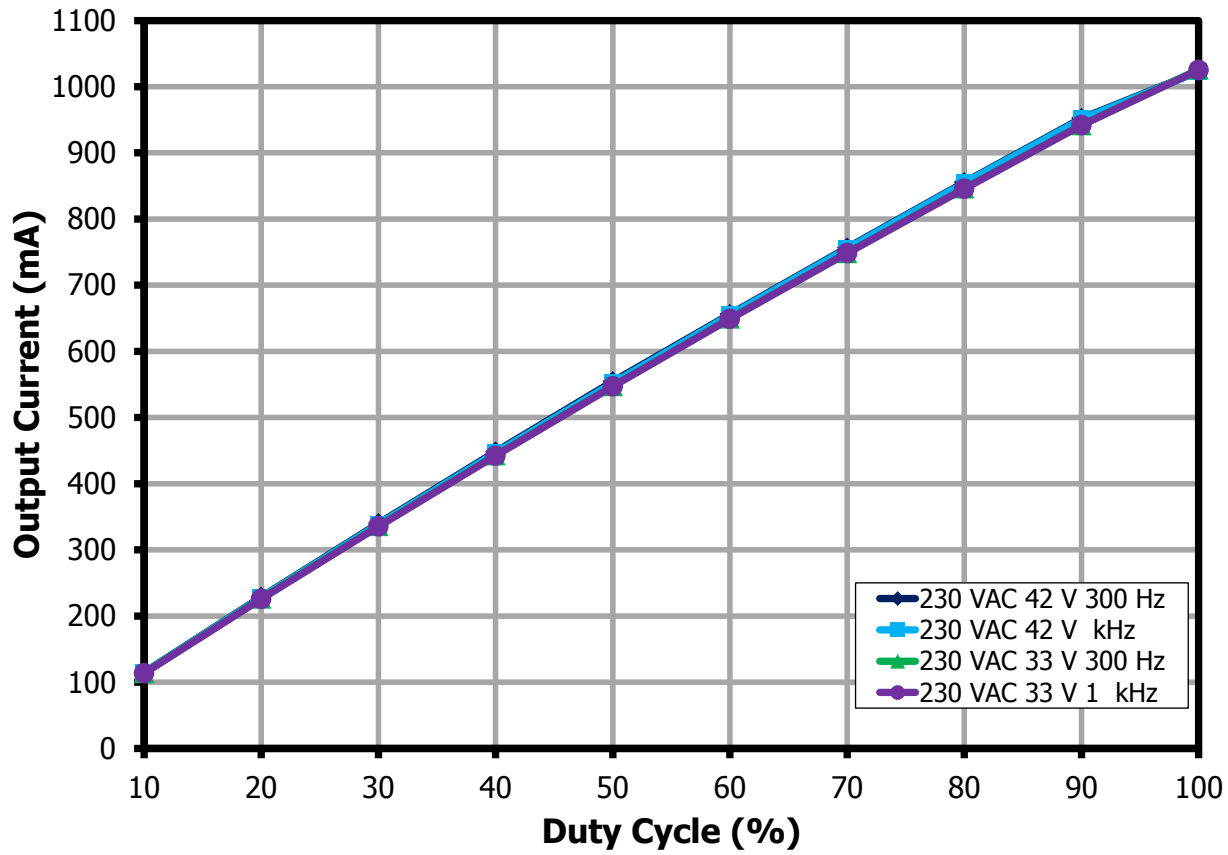
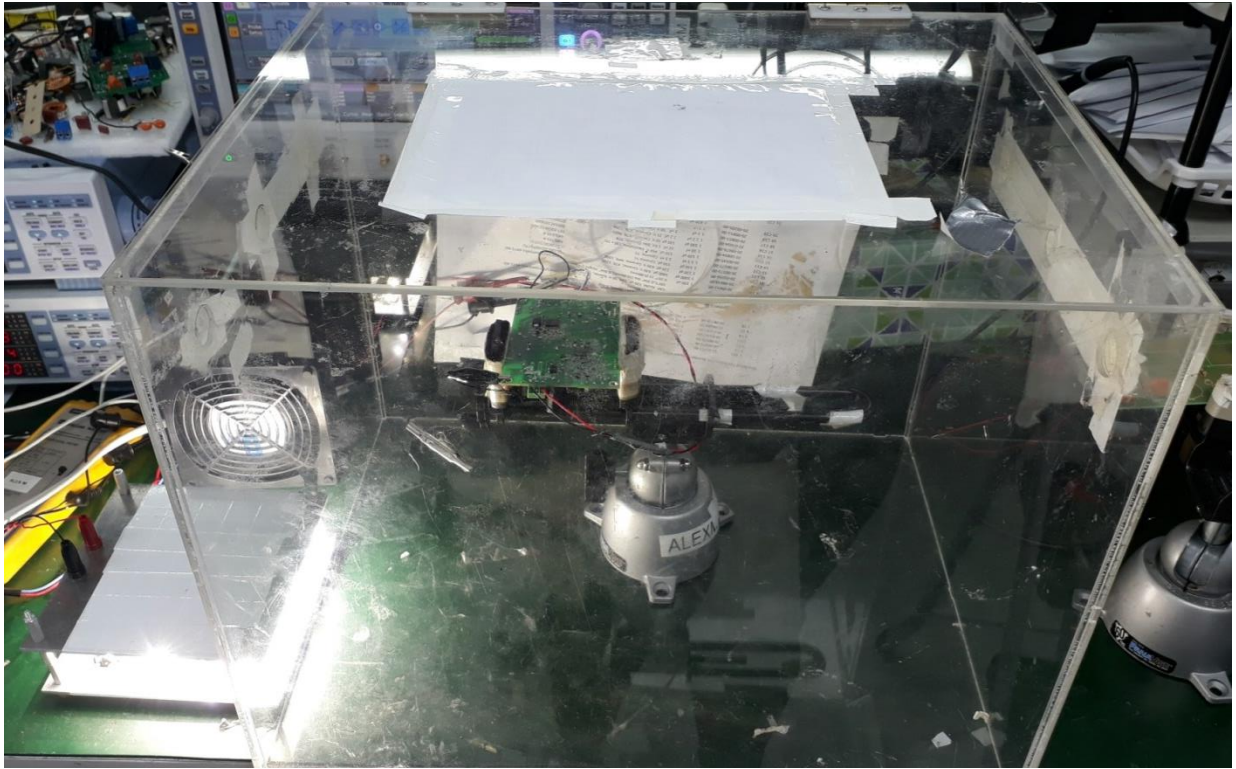


Figure 28 – 5 V PWM Dimming Curve at 42 V and 33 V LED Load 10% to 100% Duty.



## 14 Thermal Performance

### 14.1 *Thermal Scan at 25 °C Ambient*

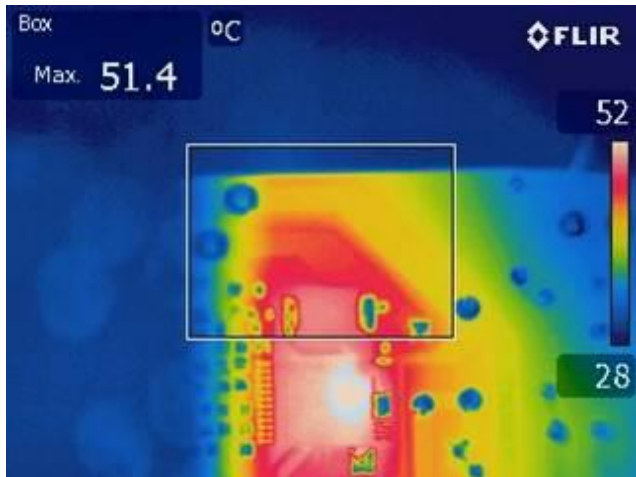


**Figure 29** – Test Set-up Picture - Open Frame.

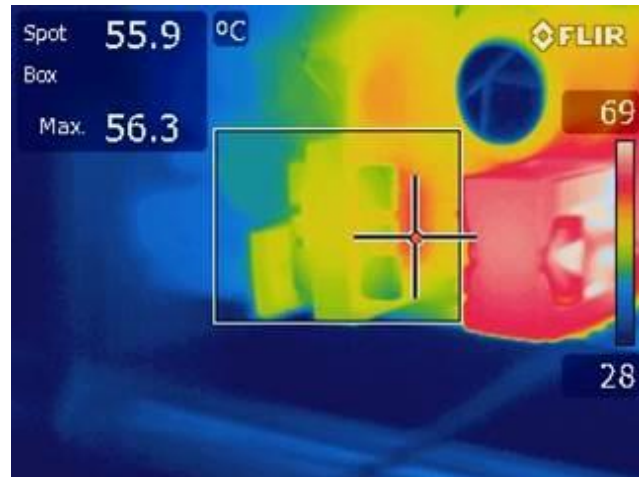
Unit in open frame was placed inside an acrylic enclosure to prevent airflow that might affect the thermal measurements. Temperature was measured using FLIR Thermal Camera.

14.1.1 Thermal Scan at 265 VAC Full Load

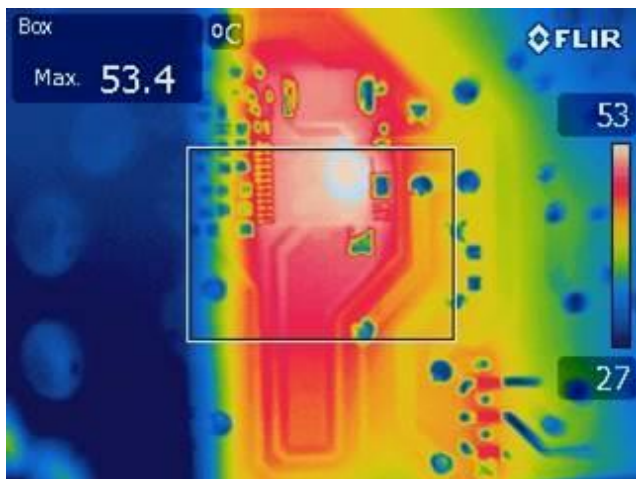
Thermal scan was performed at worst case input voltage of 265 VAC at room ambient temperature for 2 hours soak time before measurement.



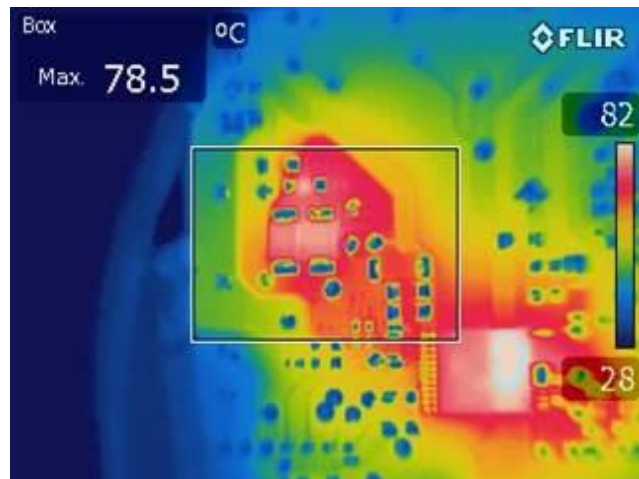
**Figure 30** – 265 VAC, 42 V LED Load.  
Box 1: Boost Diode: 51.4 °C.



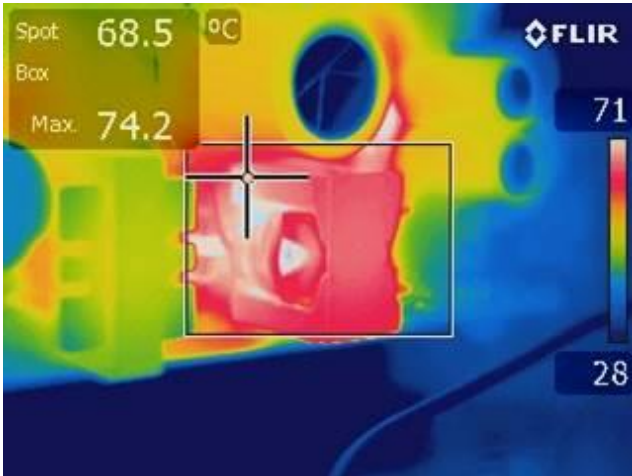
**Figure 31** – 265 VAC, 42 V LED Load.  
Box 1: PFC Inductor (T2): 56.3 °C.



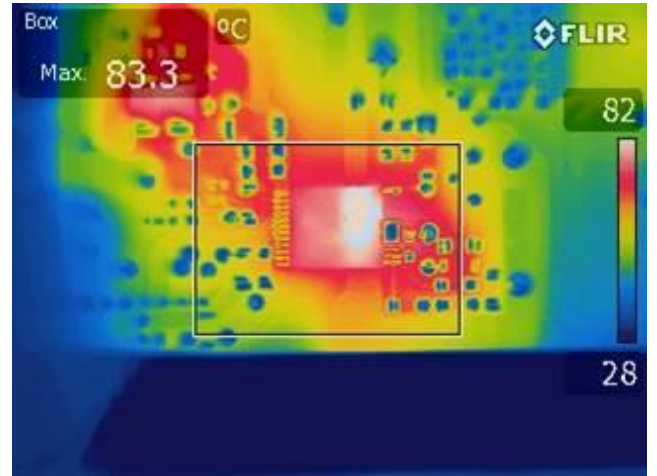
**Figure 32** – 265 VAC, 42 V LED Load.  
Box 1: PFS7623C (U2): 53.4 °C.



**Figure 33** – 265 VAC, 42 V LED Load.  
Box 1: Output Diodes: 78.5 °C.



**Figure 34** – 265 VAC, 42 V LED Load.  
Box 1: DC-DC TRF (T4): 74.2 °C.



**Figure 35** – 265 VAC, 42 V LED Load.  
Box 1: LYT6067C (U4): 83.3 °C.

## 14.2 Thermal Performance at 60 °C Ambient



**Figure 36** – Test Set-up Picture Thermal at 60 °C Ambient - Open Frame.

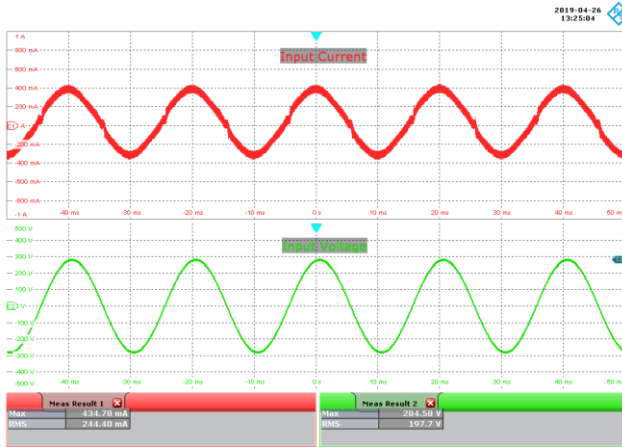
Unit in open frame was placed inside an enclosure to prevent airflow that might affect the thermal measurements. Ambient temperature inside enclosure is 60 °C. Temperature was measured using type T thermocouple after 2 hour soak time.

No.	Components	Temperature (°C)	
		198 VAC	265 VAC
1	Ambient Temperature	60.7	60.1
2	D4 – Output Diode	100.6	98.6
3	BR1 – Bridge Diode	85.6	77.7
4	D5 – Boost Diode	91	77.6
5	U2 – HiperPFS-4 Control	94.5	80.2
6	U2 – HiperPFS-4 FET	101.8	83.2
7	U4 – LYTSwitch-6 Control	100.6	97.9
8	U4 – LYTSwitch-6 FET	110.1	109.6
9	T2 – EE25 Core	83.6	77.9
10	T2 – EE25 Winding	94.9	85.6
11	T4 – PQ20/20 Core	91.6	91.3
12	T4 – PQ20/20 Winding	100.6	98.5
13	Final Output Current (mA)	986	989

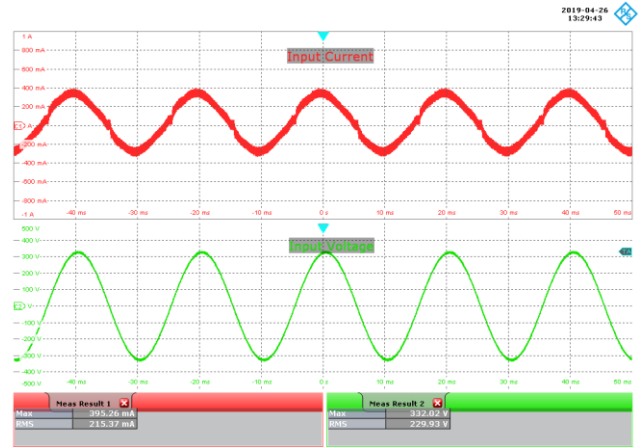


## 15 Waveforms

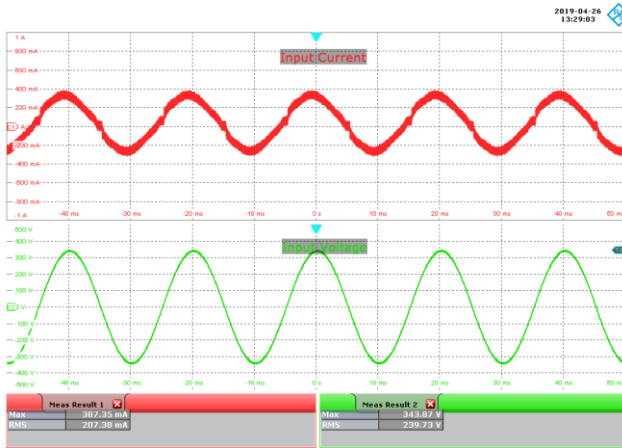
### 15.1 Input Voltage and Input Current at 42 V LED Load



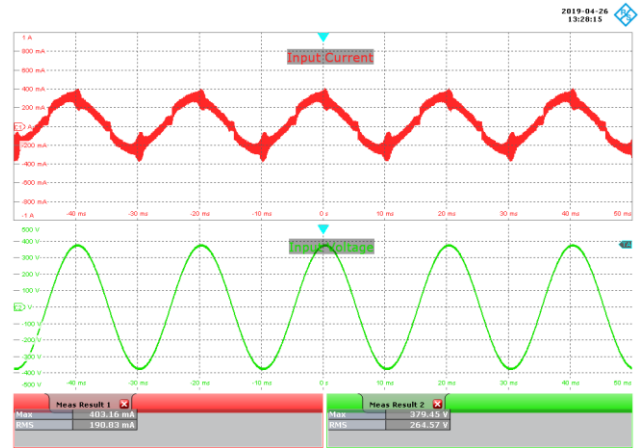
**Figure 37** – 198 VAC, 42 V LED Load.  
 Upper:  $I_{IN}$ , 200 mA / div.  
 Lower:  $V_{IN}$ , 100 V / div., 10 ms / div.



**Figure 38** – 230 VAC, 42 V LED Load.  
 Upper:  $I_{IN}$ , 200 mA / div.  
 Lower:  $V_{IN}$ , 100 V / div., 10 ms / div.

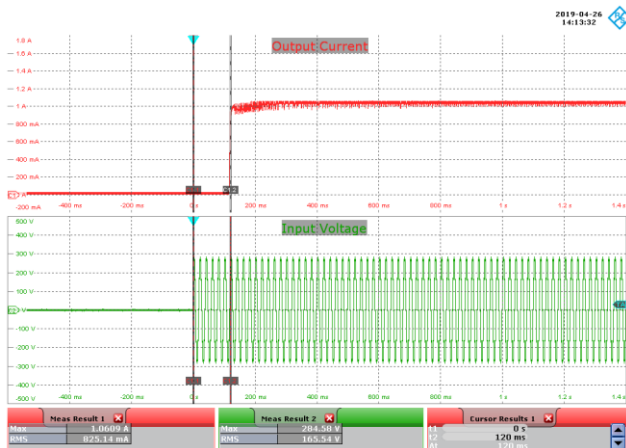


**Figure 39** – 240 VAC, 42 V LED Load.  
 Upper:  $I_{IN}$ , 200 mA / div.  
 Lower:  $V_{IN}$ , 100 V / div., 10 ms / div.

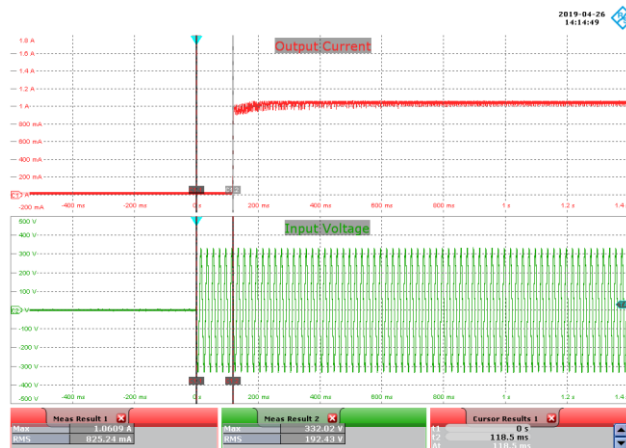


**Figure 40** – 265 VAC, 42 V LED Load.  
 Upper:  $I_{IN}$ , 200 mA / div.  
 Lower:  $V_{IN}$ , 100 V / div., 10 ms / div.

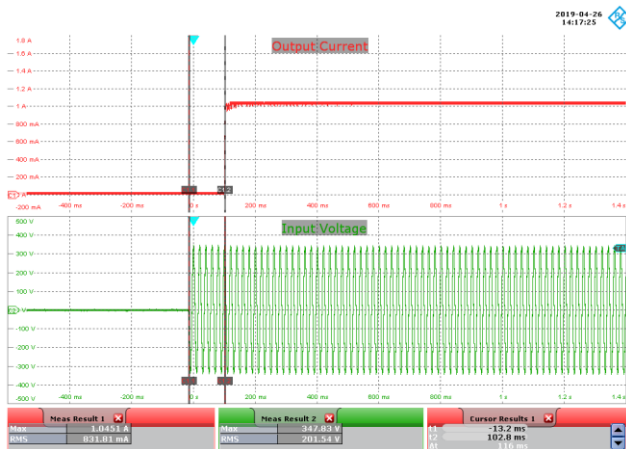
15.2 **Start-up Profile at 42 V LED Load**



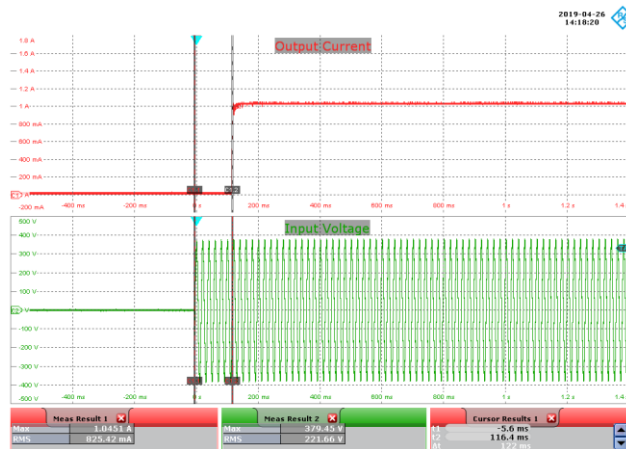
**Figure 41** – 198 VAC, 42 V LED, Output Rise.  
 Upper:  $I_{OUT}$ , 200 mA / div.  
 Lower:  $V_{IN}$ , 100 V / div., 200 ms / div.  
 Turn-on Time: 120 ms.



**Figure 42** – 230 VAC, 42 V LED, Output Rise.  
 Upper:  $I_{OUT}$ , 200 mA / div.  
 Lower:  $V_{IN}$ , 100 V / div., 200 ms / div.  
 Turn-on Time: 118.5 ms.

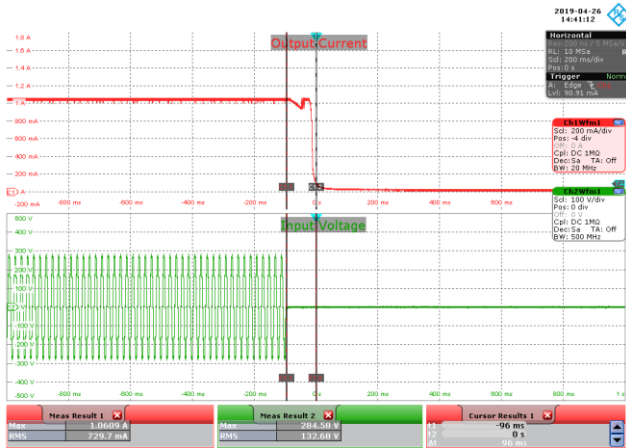


**Figure 43** – 240 VAC, 42 V LED, Output Rise.  
 Upper:  $I_{OUT}$ , 200 mA / div.  
 Lower:  $V_{IN}$ , 100 V / div., 200 ms / div.  
 Turn-on Time: 116 ms.

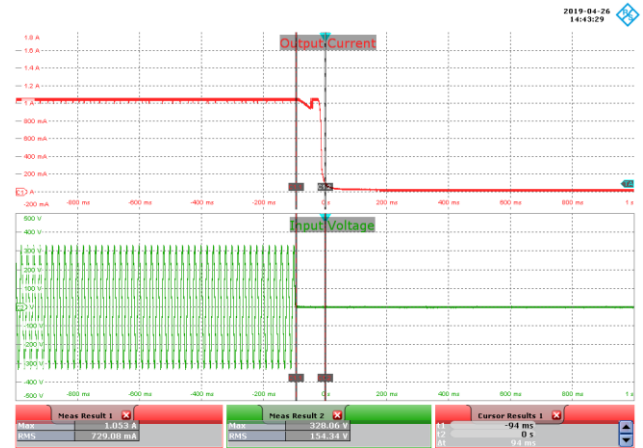


**Figure 44** – 265 VAC, 42 V LED, Output Rise.  
 Upper:  $I_{OUT}$ , 200 mA / div.  
 Lower:  $V_{IN}$ , 100 V / div., 200 ms / div.  
 Turn-on Time: 122 ms.

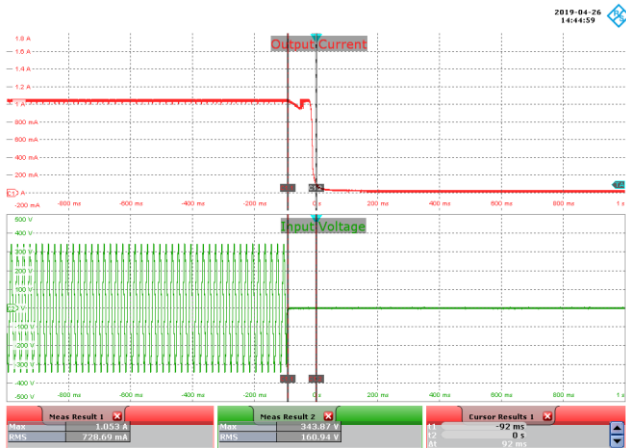
15.3 **Output Current Fall at 42 V LED Load**



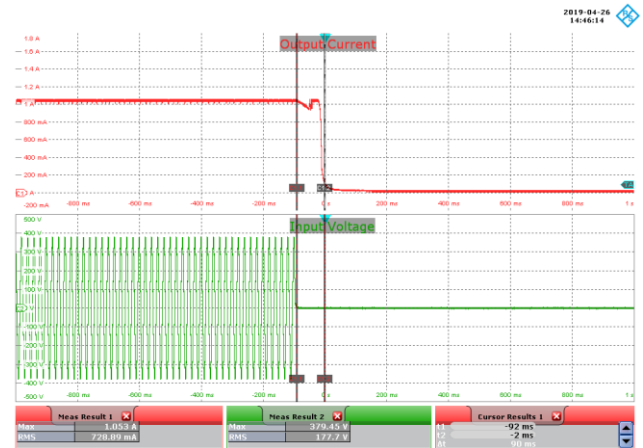
**Figure 45** – 198 VAC, 42 V LED, Output Fall.  
 Upper:  $I_{OUT}$ , 200 mA / div.  
 Lower:  $V_{IN}$ , 100 V / div., 200 ms / div.  
 Hold-up Time: 96 ms.



**Figure 46** – 230 VAC, 42 V LED, Output Fall.  
 Upper:  $I_{OUT}$ , 200 mA / div.  
 Lower:  $V_{IN}$ , 100 V / div., 200 ms / div.  
 Hold-up Time: 94ms.



**Figure 47** – 230 VAC, 42 V LED, Output Fall.  
 Upper:  $I_{OUT}$ , 200 mA / div.  
 Lower:  $V_{IN}$ , 100 V / div., 200 ms / div.  
 Hold-up Time: 92 ms.

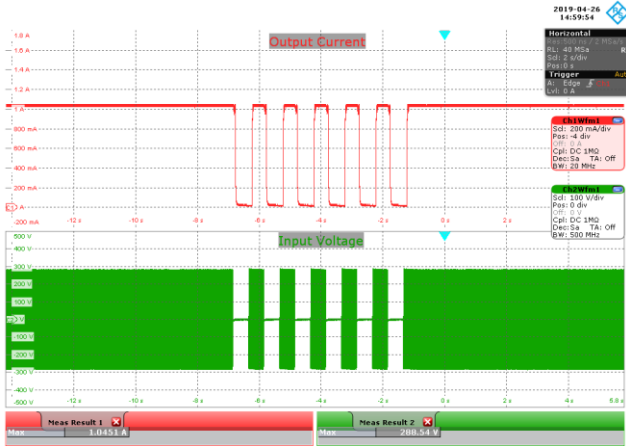


**Figure 48** – 265 VAC, 42 V LED, Output Fall.  
 Upper:  $I_{OUT}$ , 200 mA / div.  
 Lower:  $V_{IN}$ , 100 V / div., 200 ms / div.  
 Hold-up Time: 90 ms.

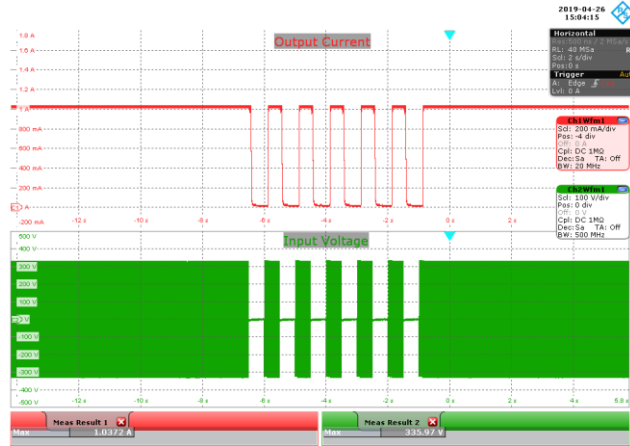
15.4 **AC Cycling Test at 42 V**

No high-voltage overshoots during ac power cycling observed.

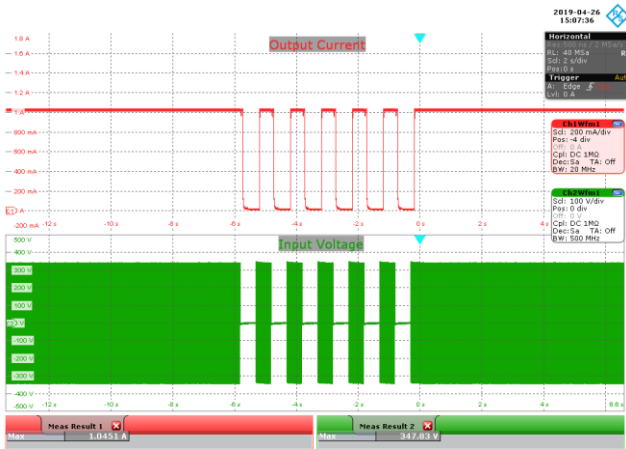
15.4.1 500 ms, OFF 500 ms ON



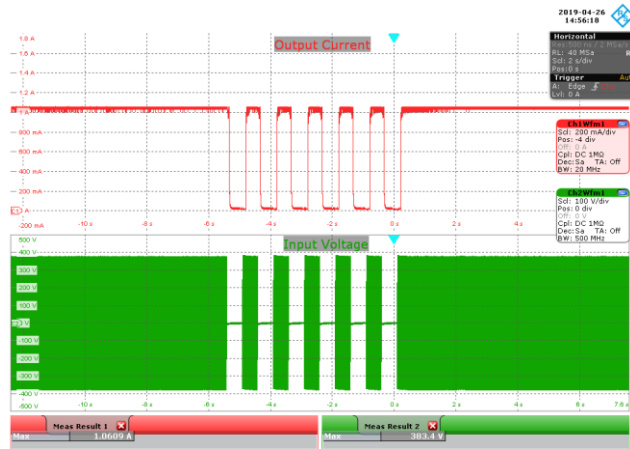
**Figure 49** – 198 VAC, 42 V LED.  
Upper:  $I_{OUT}$ , 200 mA / div.  
Lower:  $V_{IN}$ , 100 V / div., 2 s / div.



**Figure 50** – 230 VAC, 42 V LED.  
Upper:  $I_{OUT}$ , 200 mA / div.  
Lower:  $V_{IN}$ , 100 V / div., 2 s / div.



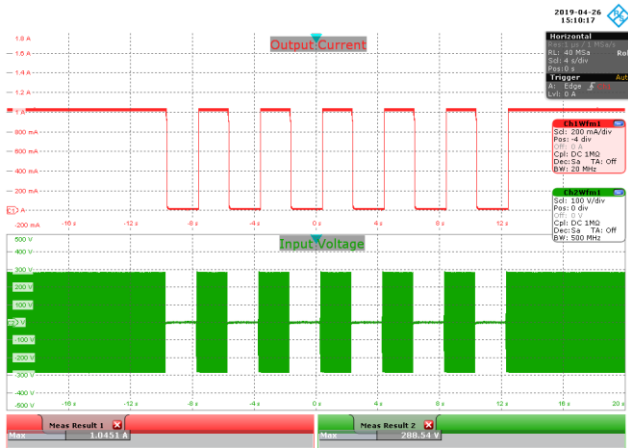
**Figure 51** – 240 VAC, 42 V LED.  
Upper:  $I_{OUT}$ , 200 mA / div.  
Lower:  $V_{IN}$ , 100 V / div., 2 s / div.



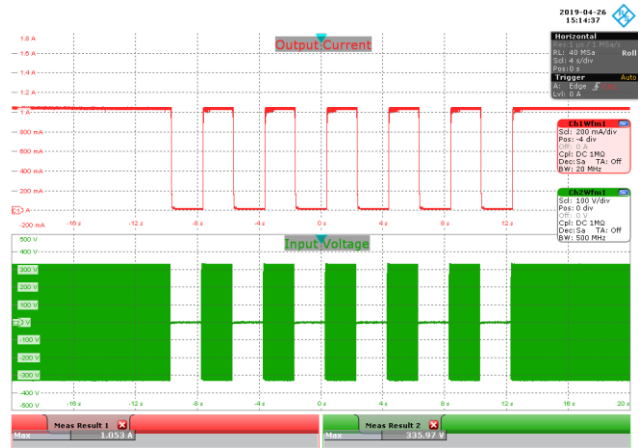
**Figure 52** – 265 VAC, 42 V LED.  
Upper:  $I_{OUT}$ , 200 mA / div.  
Lower:  $V_{IN}$ , 100 V / div., 2 s / div.



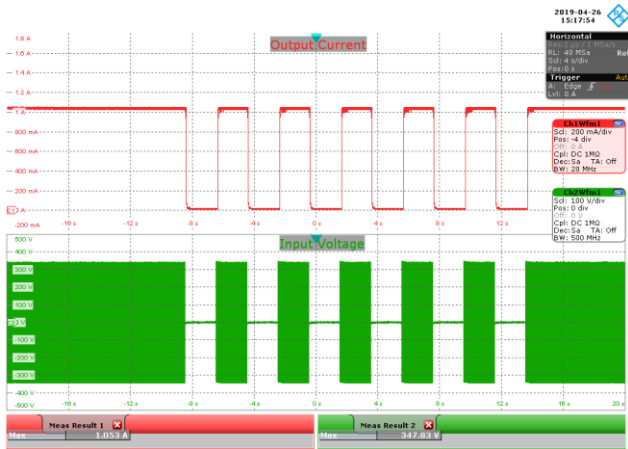
15.4.2 2 s OFF, 2 s ON



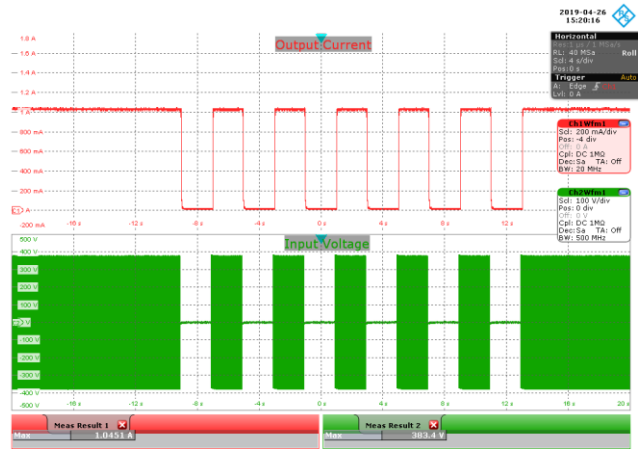
**Figure 53** – 198 VAC, 42 V LED.  
Upper:  $I_{OUT}$ , 200 mA / div.  
Lower:  $V_{IN}$ , 100 V / div., 4 s / div.



**Figure 54** – 230 VAC, 42 V LED.  
Upper:  $I_{OUT}$ , 200 mA / div.  
Lower:  $V_{IN}$ , 100 V / div., 4 s / div.

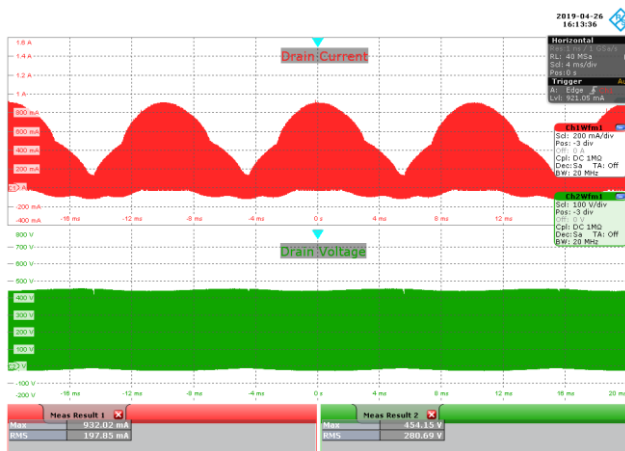


**Figure 55** – 240 VAC, 42 V LED.  
Upper:  $I_{OUT}$ , 200 mA / div.  
Lower:  $V_{IN}$ , 100 V / div., 4 s / div.

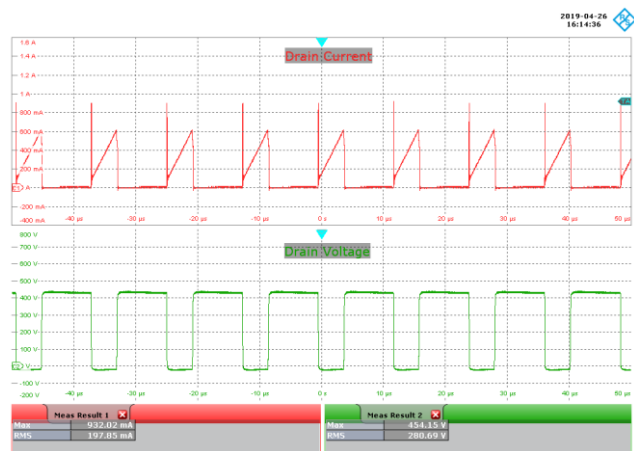


**Figure 56** – 265 VAC, 42 V LED.  
Upper:  $I_{OUT}$ , 200 mA / div.  
Lower:  $V_{IN}$ , 100 V / div., 4 s / div.

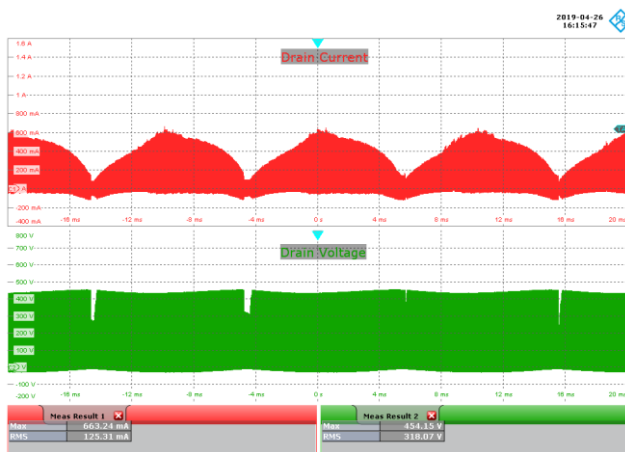
15.5 **PFS7623C (U2) Drain Voltage and Current at Normal Operation**



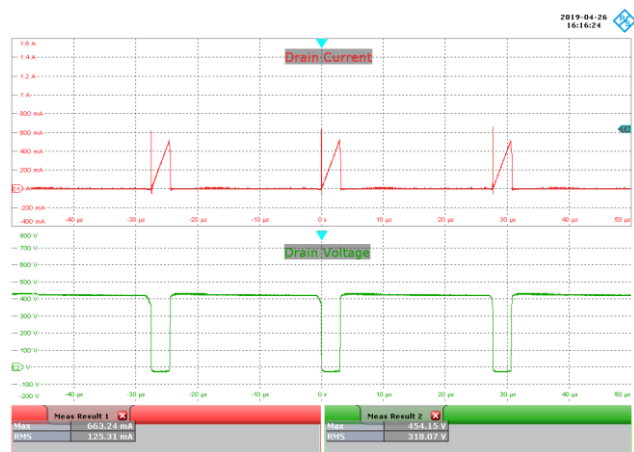
**Figure 57** – 198 VAC, 42 V LED Load.  
 Upper:  $I_{DRAIN}$ , 200 mA / div.  
 Lower:  $V_{DRAIN}$ , 100 V / div., 4 ms / div.



**Figure 58** – 198 VAC, 42V LED Load.  
 Upper:  $I_{DRAIN}$ , 200 mA / div.  
 Lower:  $V_{DRAIN}$ , 100 V / div., 10  $\mu$ s / div.

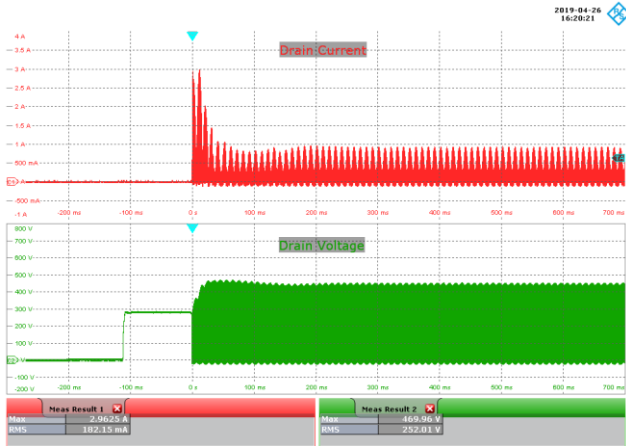


**Figure 59** – 265 VAC, 42 V LED Load.  
 Upper:  $I_{DRAIN}$ , 200 mA / div.  
 Lower:  $V_{DRAIN}$ , 100 V / div., 4 ms / div.

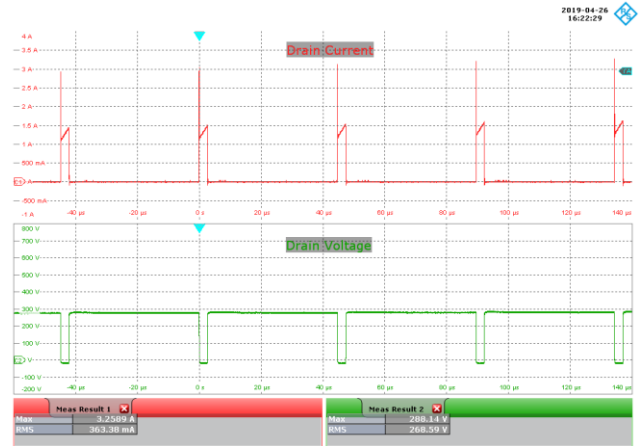


**Figure 60** – 265 VAC, 42 V LED Load.  
 Upper:  $I_{DRAIN}$ , 200 mA / div.  
 Lower:  $V_{DRAIN}$ , 100 V / div., 10  $\mu$ s / div.

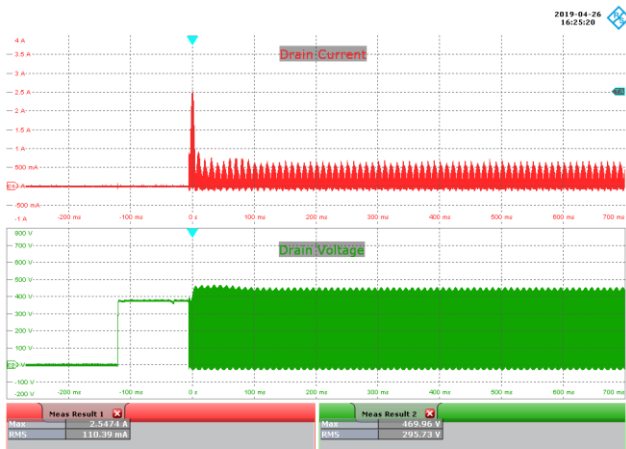
15.6 **PFS7623C (U2) Drain Voltage and Current at Start-up**



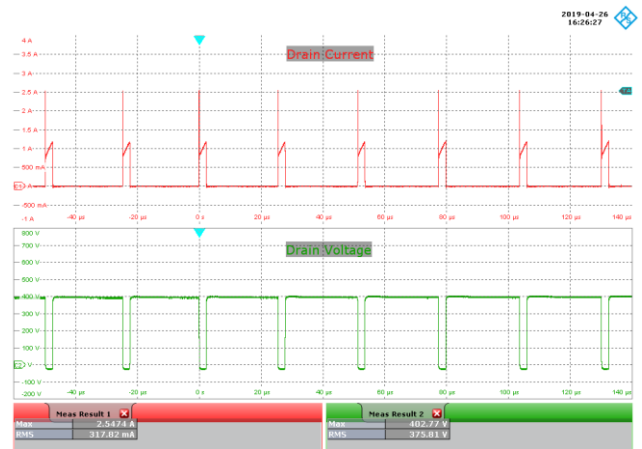
**Figure 61** – 198 VAC, 42 V LED Load.  
Upper:  $I_{DRAIN}$ , 500 mA / div.  
Lower:  $V_{DRAIN}$ , 100 V / div., 100 ms / div.



**Figure 62** – 198 VAC, 42 V LED Load.  
Upper:  $I_{DRAIN}$ , 500 mA / div.  
Lower:  $V_{DRAIN}$ , 100 V / div., 20  $\mu$ s / div.



**Figure 63** – 265 VAC, 42 V LED Load.  
Upper:  $I_{DRAIN}$ , 500 mA / div.  
Lower:  $V_{DRAIN}$ , 100 V / div., 100 ms / div.

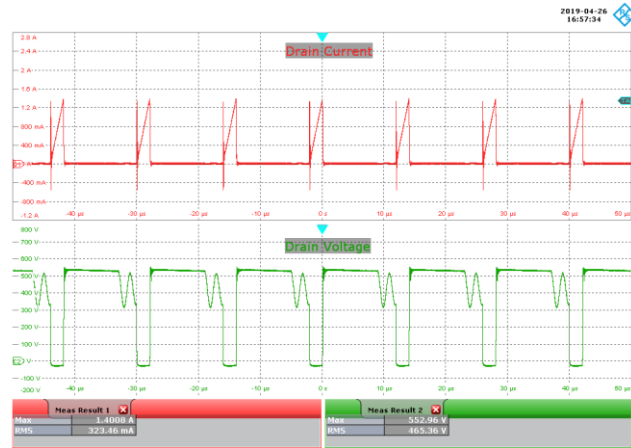


**Figure 64** – 265 VAC, 42 V LED Load.  
Upper:  $I_{DRAIN}$ , 500 mA / div.  
Lower:  $V_{DRAIN}$ , 100 V / div., 20  $\mu$ s / div.

15.7 **LYTSwitch-6 (U4) Drain Voltage and Current at Normal Operation**



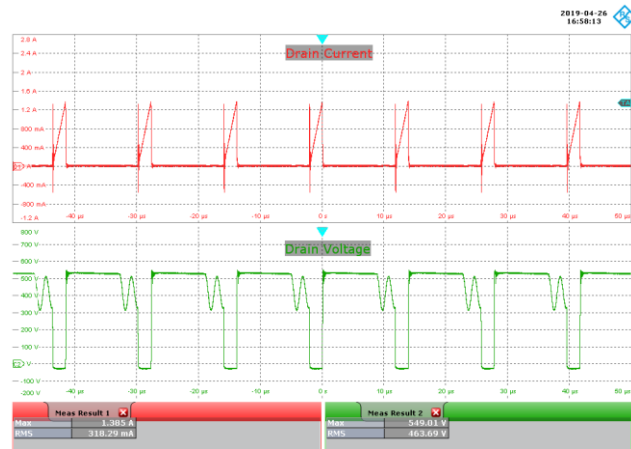
**Figure 65** – 198 VAC, 42 V LED Load.  
 Upper:  $I_{DRAIN}$ , 400 mA / div.  
 Lower:  $V_{DRAIN}$ , 100 V / div., 4 ms / div.



**Figure 66** – 198 VAC, 42 V LED Load.  
 Upper:  $I_{DRAIN}$ , 400 mA / div.  
 Lower:  $V_{DRAIN}$ , 100 V / div., 10  $\mu$ s / div.



**Figure 67** – 230 VAC, 42 V LED Load.  
 Upper:  $I_{DRAIN}$ , 400 mA / div.  
 Lower:  $V_{DRAIN}$ , 100 V / div., 4 ms / div.



**Figure 68** – 230 VAC, 42 V LED Load.  
 Upper:  $I_{DRAIN}$ , 400 mA / div.  
 Lower:  $V_{DRAIN}$ , 100 V / div., 10  $\mu$ s / div.



**Figure 69** – 265 VAC, 42 V LED Load.  
 Upper:  $I_{DRAIN}$ , 400 mA / div.  
 Lower:  $V_{DRAIN}$ , 100 V / div., 4 ms / div.

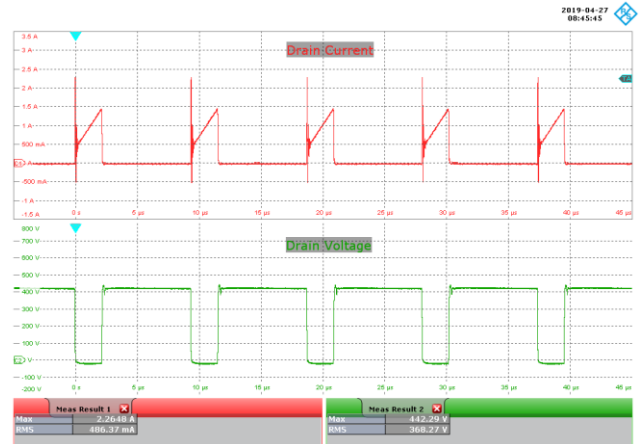


**Figure 70** – 265 VAC, 42 V LED Load.  
 Upper:  $I_{DRAIN}$ , 400 mA / div.  
 Lower:  $V_{DRAIN}$ , 100 V / div., 10  $\mu$ s / div.

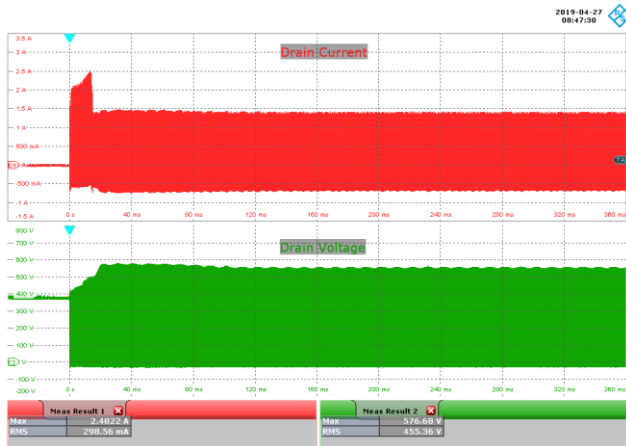
### 15.8 *LYTSwitch-6 (U4) Drain Voltage and Current at Start-up*



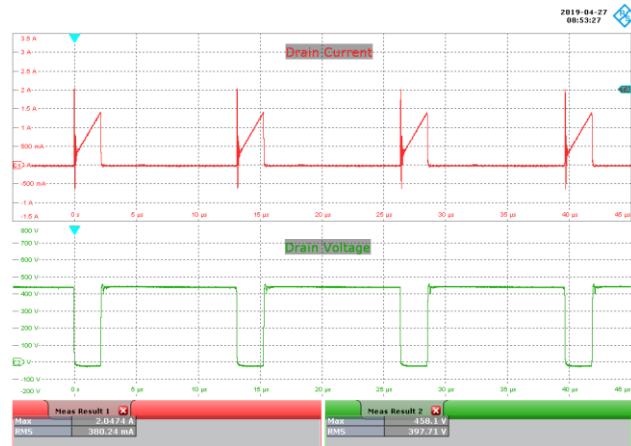
**Figure 71** – 198 VAC, 42 V LED Load.  
 Upper:  $I_{DRAIN}$ , 400 mA / div.  
 Lower:  $V_{DRAIN}$ , 100 V / div., 40 ms / div.



**Figure 72** – 198 VAC, 42 V LED Load.  
 Upper:  $I_{DRAIN}$ , 400 mA / div.  
 Lower:  $V_{DRAIN}$ , 100 V / div., 5  $\mu$ s / div.

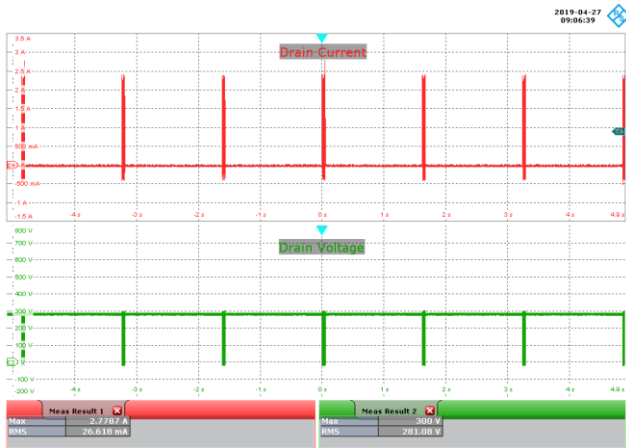


**Figure 73** – 265 VAC, 42 V LED Load.  
 Upper:  $I_{DRAIN}$ , 400 mA / div.  
 Lower:  $V_{DRAIN}$ , 100 V / div., 40 ms / div.

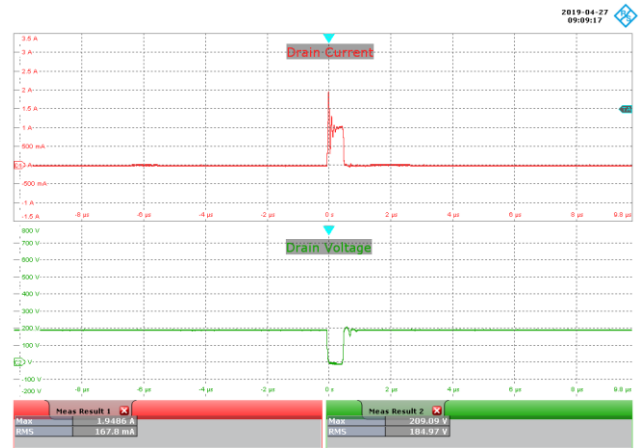


**Figure 74** – 265 VAC, 42 V LED Load.  
 Upper:  $I_{DRAIN}$ , 400 mA / div.  
 Lower:  $V_{DRAIN}$ , 100 V / div., 5  $\mu$ s / div.

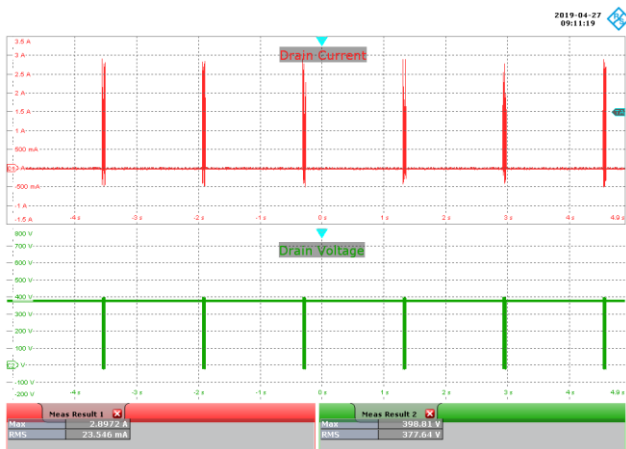
15.9 **LYTSwitch-6 (U4) Drain Voltage and Current during Output Short-Circuit**



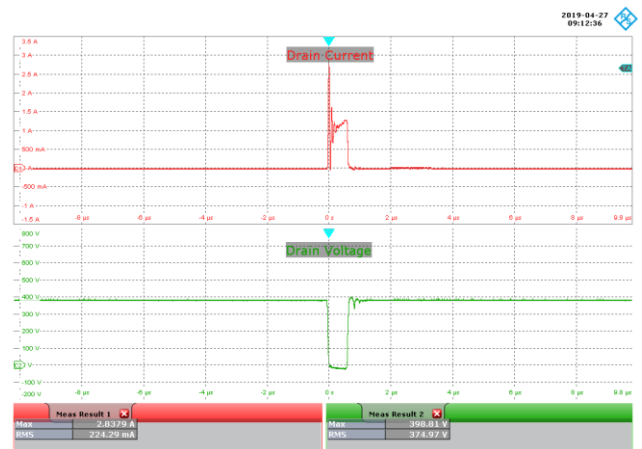
**Figure 75** – 198 VAC, Output Shorted.  
Upper:  $I_{DRAIN}$ , 500 mA / div.  
Lower:  $V_{DRAIN}$ , 100 V / div., 1 s / div.



**Figure 76** – 198 VAC, Output Shorted.  
Upper:  $I_{DRAIN}$ , 500 mA / div.  
Lower:  $V_{DRAIN}$ , 100 V / div., 2  $\mu$ s / div.



**Figure 77** – 265 VAC, Output Shorted.  
Upper:  $I_{DRAIN}$ , 500 mA / div.  
Lower:  $V_{DRAIN}$ , 100 V / div., 1 s / div.



**Figure 78** – 265 VAC, Output Shorted.  
Upper:  $I_{DRAIN}$ , 500 mA / div.  
Lower:  $V_{DRAIN}$ , 100 V / div., 2  $\mu$ s / div.

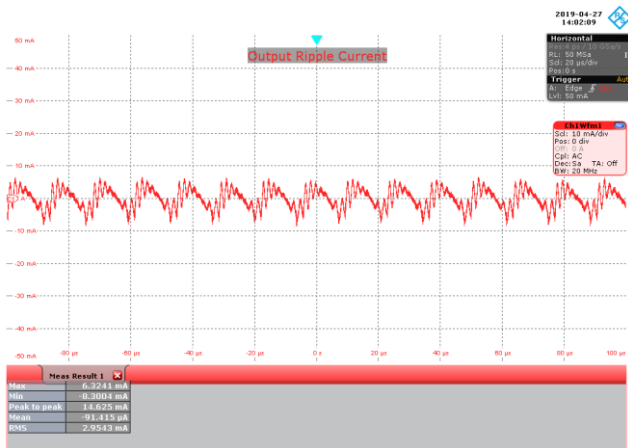
15.10 **Input Power during Output Short-Circuit**

Test data measured after 5 min integration time with dimming circuit disabled.

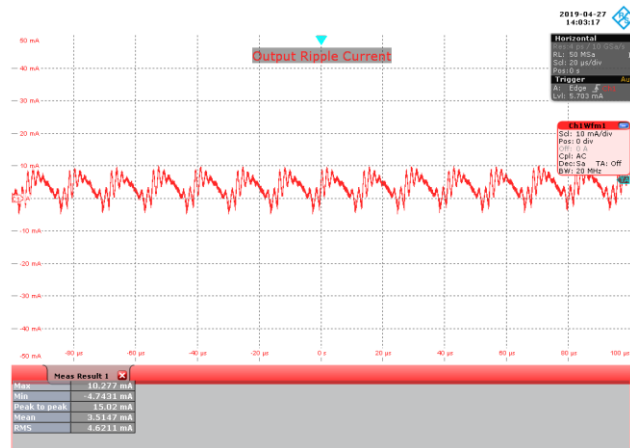
Input Power at Output Short		
VAC ( $V_{RMS}$ )	Frequency (Hz)	P (W)
198	50	0.094
230	50	0.113
265	50	0.136



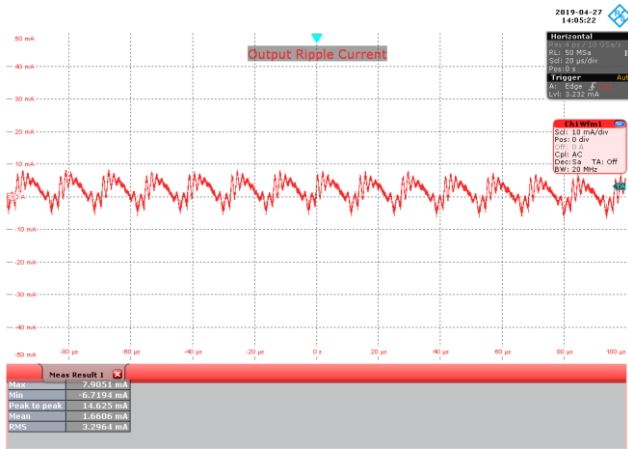
15.11 **Output Ripple Current at 42 V LED Load**



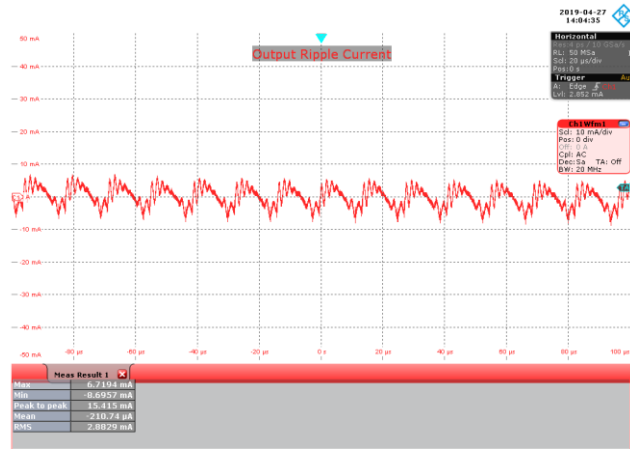
**Figure 79** – 198 VAC, 50 Hz, 42 V LED Load.  
Upper:  $I_{OUT}$ , 10 mA / div., 20 us / div.



**Figure 80** – 230 VAC, 50 Hz, 42 V LED Load.  
Upper:  $I_{OUT}$ , 10 mA / div., 20 us / div.



**Figure 81** – 240 VAC, 50 Hz, 42 V LED Load.  
Upper:  $I_{OUT}$ , 10 mA / div., 20 us / div.



**Figure 82** – 265 VAC, 50 Hz, 42 V LED Load.  
Upper:  $I_{OUT}$ , 10 mA / div., 20 us / div.

$V_{IN}$ (VAC)	$I_{PK-PK}$ (mA)	$I_{MEAN}$ (mA)	% Ripple	% Flicker
			$100 \times (I_{RP-P}) / (I_{OUT})$	$100 \times (I_{RP-P}) / (2 \times I_{OUT})$
198	14.63	1030	1.42	0.71
230	15.02		1.46	0.73
240	14.63		1.42	0.71
265	15.42		1.50	0.75



## 16 Conducted EMI

### 16.1 *Test Set-up*

LED metal heat sink is connected to earth. Unit with input ground wire connection is placed on top of LED metal heat sink. The data were measured after 15 minutes of soak time. See below set-up picture.

### 16.2 *Equipment and Load Used*

1. Rohde and Schwarz ENV216 two line V-network.
2. Rohde and Schwarz ESRP EMI test receiver.
3. Hioki 3322 power hitester.
4. Chroma measurement test fixture.
5. 42 V LED load with input voltage set at 230 VAC.



**Figure 83** – Conducted EMI Test Set-up.

16.2.1 EMI Test Results



Date: 24.APR.2019 15:23:03

Figure 84 – Conducted EMI QP Scan at 42 V LED Load, 230 VAC, 60 Hz, and EN55015 B Limits.

Trace1: EN55015Q.LIN		Trace2: EN55022A.LIN	
Trace/Detector	Frequency	Level dBµV	DeltaLimit
2 Average	321.0000 kHz	41.95 N	-7.73 dB
1 Quasi Peak	61.2000 kHz	78.50 N	-9.66 dB
1 Quasi Peak	62.6000 kHz	75.00 L1	-12.95 dB
1 Quasi Peak	65.4000 kHz	74.43 L1	-13.13 dB
1 Quasi Peak	66.1500 kHz	73.94 L1	-13.51 dB
1 Quasi Peak	282.7500 kHz	47.15 L1	-13.58 dB
1 Quasi Peak	64.6500 kHz	73.99 L1	-13.67 dB
1 Quasi Peak	63.7000 kHz	73.97 L1	-13.83 dB
2 Average	159.0000 kHz	40.04 L1	-15.48 dB
2 Average	510.0000 kHz	29.62 N	-16.38 dB
2 Average	582.0000 kHz	29.33 N	-16.67 dB
1 Quasi Peak	1.4415 MHz	38.92 N	-17.08 dB
2 Average	1.5990 MHz	28.41 N	-17.59 dB
2 Average	21.6628 MHz	31.33 N	-18.67 dB

Symbols  OFF  ON
 
 Decim Sep

Figure 85 – Conducted EMI Data at 230 VAC, 42 V LED Load.

## 17 Line Surge

The unit was subjected to  $\pm 2500$  V, 100 kHz ring wave and  $\pm 1000$  V differential surge with 10 strikes at each condition. A test failure was defined as a non-recoverable interruption of output requiring repair or recycling of input voltage.

### 17.1 Differential Surge Test Results

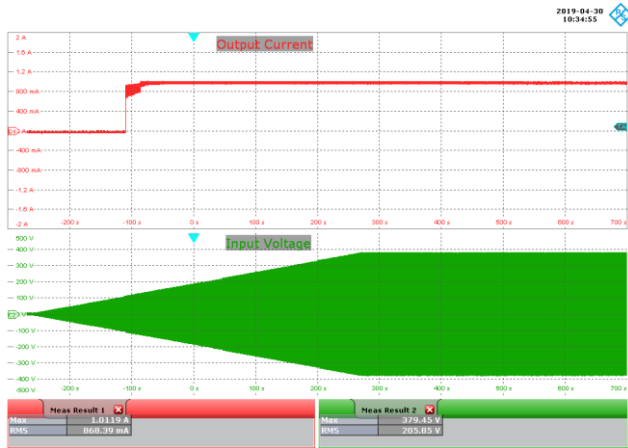
Surge Level (V)	Input Voltage (VAC)	Injection Location	Injection Phase (°)	Line Impedance ( $\Omega$ )	Test Result (Pass/Fail)
+1000	230	L to N	0	2	Pass
-1000	230	L to N	0	2	Pass
+1000	230	L to N	90	2	Pass
-1000	230	L to N	90	2	Pass
+1000	230	L to N	270	2	Pass
-1000	230	L to N	270	2	Pass

### 17.2 Ring Wave Surge Test Results

Surge Level (V)	Input Voltage (VAC)	Injection Location	Injection Phase (°)	Line Impedance ( $\Omega$ )	Test Result (Pass/Fail)
+2500	230	L to N	0	12	Pass
-2500	230	L to N	0	12	Pass
+2500	230	L to N	90	12	Pass
-2500	230	L to N	90	12	Pass
+2500	230	L to N	270	12	Pass
-2500	230	L to N	270	12	Pass

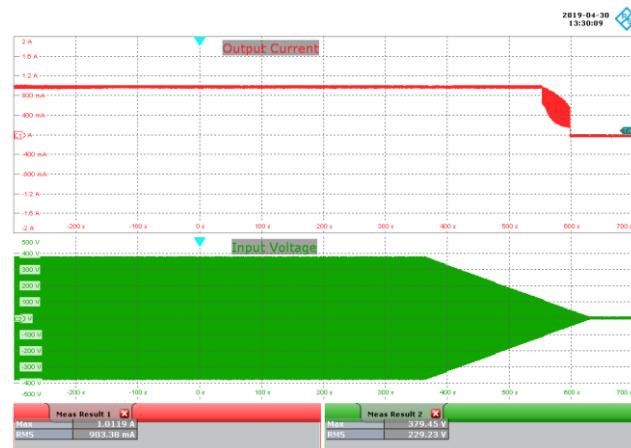
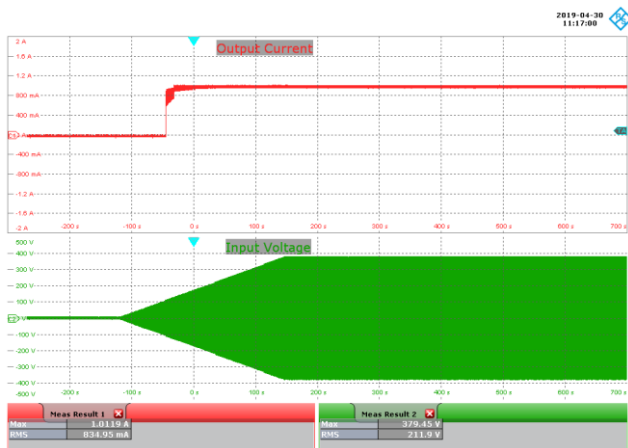
### 18 Brown-in/Brown-out Test

No abnormal overheating, current overshoot/undershoot was observed during and after 0.5 V / s and 1 V / s brown-in and brown-out test.



**Figure 86** – Brown-in Test at 0.5 V / s.  
 Ch1:  $I_{OUT}$ , 400 mA / div.  
 Ch2:  $V_{IN}$ , 100 V / div.  
 Time Scale: 100 s / div.

**Figure 87** – Brown-out Test at 0.5 V / s  
 Ch1:  $I_{OUT}$ , 400 mA / div.  
 Ch2:  $V_{IN}$ , 100 V / div.  
 Time Scale: 100 s / div.



**Figure 88** – Brown-in Test at 1 V / s.  
 Ch1:  $I_{OUT}$ , 400 mA / div.  
 Ch2:  $V_{IN}$ , 100 V / div.  
 Time Scale: 100 s / div.

**Figure 89** – Brown-out Test at 1 V / s.  
 Ch1:  $I_{OUT}$ , 400 mA / div.  
 Ch2:  $V_{IN}$ , 100 V / div.  
 Time Scale: 100 s / div.

**19 Revision History**

<b>Date</b>	<b>Author</b>	<b>Revision</b>	<b>Description and Changes</b>	<b>Reviewed</b>
20-Jan-20	CA	1.0	Initial Release.	Apps & Mktg



**For the latest updates, visit our website: [www.power.com](http://www.power.com)**

Reference Designs are technical proposals concerning how to use Power Integrations' gate drivers in particular applications and/or with certain power modules. These proposals are "as is" and are not subject to any qualification process. The suitability, implementation and qualification are the sole responsibility of the end user. The statements, technical information and recommendations contained herein are believed to be accurate as of the date hereof. All parameters, numbers, values and other technical data included in the technical information were calculated and determined to our best knowledge in accordance with the relevant technical norms (if any). They may base on assumptions or operational conditions that do not necessarily apply in general. We exclude any representation or warranty, express or implied, in relation to the accuracy or completeness of the statements, technical information and recommendations contained herein. No responsibility is accepted for the accuracy or sufficiency of any of the statements, technical information, recommendations or opinions communicated and any liability for any direct, indirect or consequential loss or damage suffered by any person arising therefrom is expressly disclaimed.

Power Integrations reserves the right to make changes to its products at any time to improve reliability or manufacturability. Power Integrations does not assume any liability arising from the use of any device or circuit described herein. POWER INTEGRATIONS MAKES NO WARRANTY HEREIN AND SPECIFICALLY DISCLAIMS ALL WARRANTIES INCLUDING, WITHOUT LIMITATION, THE IMPLIED WARRANTIES OF MERCHANTABILITY, FITNESS FOR A PARTICULAR PURPOSE, AND NON-INFRINGEMENT OF THIRD PARTY RIGHTS.

**Patent Information**

The products and applications illustrated herein (including transformer construction and circuits' external to the products) may be covered by one or more U.S. and foreign patents, or potentially by pending U.S. and foreign patent applications assigned to Power Integrations. A complete list of Power Integrations' patents may be found at [www.power.com](http://www.power.com). Power Integrations grants its customers a license under certain patent rights as set forth at <http://www.power.com/ip.htm>.

Power Integrations, the Power Integrations logo, CAPZero, ChiPhy, CHY, DPA-Switch, EcoSmart, E-Shield, eSIP, eSOP, HiperPLC, HiperPFS, HiperTFS, InnoSwitch, Innovation in Power Conversion, InSOP, LinkSwitch, LinkZero, LYTSwitch, SENZero, TinySwitch, TOPSwitch, PI, PI Expert, PowiGaN, SCALE, SCALE-1, SCALE-2, SCALE-3 and SCALE-iDriver, are trademarks of Power Integrations, Inc. Other trademarks are property of their respective companies. ©2019, Power Integrations, Inc.

**Power Integrations Worldwide Sales Support Locations****WORLD HEADQUARTERS**

5245 Hellyer Avenue  
San Jose, CA 95138, USA.  
Main: +1-408-414-9200  
Customer Service:  
Worldwide: +1-65-635-64480  
Americas: +1-408-414-9621  
e-mail: [usasales@power.com](mailto:usasales@power.com)

**CHINA (SHANGHAI)**

Rm 2410, Charity Plaza, No. 88,  
North Caoxi Road,  
Shanghai, PRC 200030  
Phone: +86-21-6354-6323  
e-mail: [chinasales@power.com](mailto:chinasales@power.com)

**CHINA (SHENZHEN)**

17/F, Hivac Building, No. 2, Keji  
Nan 8th Road, Nanshan District,  
Shenzhen, China, 518057  
Phone: +86-755-8672-8689  
e-mail: [chinasales@power.com](mailto:chinasales@power.com)

**GERMANY (AC-DC/LED Sales)**

Einsteinring 24  
85609 Dornach/Aschheim  
Germany  
Tel: +49-89-5527-39100  
e-mail: [eurosales@power.com](mailto:eurosales@power.com)

**GERMANY (Gate Driver Sales)**

HellwegForum 1  
59469 Ense  
Germany  
Tel: +49-2938-64-39990  
e-mail: [igbt-driver.sales@power.com](mailto:igbt-driver.sales@power.com)

**INDIA**

#1, 14<sup>th</sup> Main Road  
Vasanthanagar  
Bangalore-560052  
India  
Phone: +91-80-4113-8020  
e-mail: [indiasales@power.com](mailto:indiasales@power.com)

**ITALY**

Via Milanese 20, 3<sup>rd</sup>. Fl.  
20099 Sesto San Giovanni (MI) Italy  
Phone: +39-024-550-8701  
e-mail: [eurosales@power.com](mailto:eurosales@power.com)

**JAPAN**

Yusen Shin-Yokohama 1-chome Bldg.  
1-7-9, Shin-Yokohama, Kohoku-ku  
Yokohama-shi,  
Kanagawa 222-0033 Japan  
Phone: +81-45-471-1021  
e-mail: [japansales@power.com](mailto:japansales@power.com)

**KOREA**

RM 602, 6FL  
Korea City Air Terminal B/D,  
159-6  
Samsung-Dong, Kangnam-Gu,  
Seoul, 135-728 Korea  
Phone: +82-2-2016-6610  
e-mail: [koreasales@power.com](mailto:koreasales@power.com)

**SINGAPORE**

51 Newton Road,  
#19-01/05 Goldhill Plaza  
Singapore, 308900  
Phone: +65-6358-2160  
e-mail: [singaporeales@power.com](mailto:singaporeales@power.com)

**TAIWAN**

5F, No. 318, Nei Hu Rd.,  
Sec. 1  
Nei Hu District  
Taipei 11493, Taiwan R.O.C.  
Phone: +886-2-2659-4570  
e-mail: [taiwansales@power.com](mailto:taiwansales@power.com)

**UK**

Building 5, Suite 21  
The Westbrook Centre  
Milton Road  
Cambridge  
CB4 1YG  
Phone: +44 (0) 7823-557484  
e-mail: [eurosales@power.com](mailto:eurosales@power.com)

